

Hall Ticket No:

--	--	--	--	--	--	--	--	--	--

Question Paper Code: 23HUM101

MADANAPALLE INSTITUTE OF TECHNOLOGY & SCIENCE, MADANAPALLE
(UGC-AUTONOMOUS)**B. Tech II Year I Semester (R23) Regular End Semester Examinations, December – 2024**
UNIVERSAL HUMAN VALUES

(Common to All)

Time: 3Hrs

Max Marks: 70

Attempt all the questions. All parts of the question must be answered in one place only.
All parts of Q.no 1 are compulsory. In Q.no 2 to 6 answer either A or B only

Q.No	Question	Marks	CO	BL
Q.1	i. Define the value of a unit with an example	1M	1	1
	ii. Differentiate between value and price of a unit.	1M	1	2
	iii. Name responses related to the body of a human being	1M	2	1
	iv. Write the meaning of prosperity	1M	2	1
	v. Write any two aspects of the relationship	1M	3	1
	vi. Differentiate between "excellence" and "Competition".	1M	3	2
	vii. Write the innateness of bio-order	1M	4	1
	viii. Name the two types of units that are broadly classified in existence	1M	4	1
	ix. State the term "Ethical conduct of Profession".	1M	5	2
	x. Outline the term "Human Education".	1M	5	2
Q.2(A)	(i) Distinguish between 'animal consciousness' and 'human consciousness'	8M	1	2
	(ii) Mention the sources of happiness and temporary happiness.	4M	1	2
OR				
Q.2(B)	What are the basic human aspirations and what are the requirements to fulfill them? Indicate their correct priority. Support your answer with two examples	12M	1	2
Q.3(A)	i) Explain in detail how a human being is the co-existence of self and body.	8M	2	2
	ii) What is the gross misunderstanding about a human being? What is the outcome of it?	4M	2	2
OR				
Q.3(B)	List the various sources of imagination in the self. Elaborate with a few examples and explain how the harmony in the self is ensured in continuity.	12M	2	2
Q.4(A)	i) Describe the feeling of trust and evaluate it between two individuals. Give one example from your own experience.	8M	3	2
	ii) Briefly explain the terms "care" and "guidance".	4M	3	2
OR				
Q.4(B)	Discuss how five systems/dimensions assists to fulfil the four human goals to achieve harmony in the society	12M	3	2
Q.5(A)	Why is the human order, by and large, not mutually fulfilling for any of the four orders? Is your natural acceptance to be fulfilling for all four orders? Explain what human being needs to do to be mutually fulfilling for each of the four orders?	12M	4	2
OR				
Q.5(B)	Draw a chart showing all the different categories of units of nature in space.	12M	4	2
Q.6(A)	Explain the implications of value-based living at all the levels of human being (individual, family, Society and nature/existence).	12M	5	2
OR				
Q.6(B)	Identify the holistic criteria for the evaluation of technologies, production systems and management models.	12M	5	2

*** END***

Hall Ticket No:

--	--	--	--	--	--	--	--	--	--

Question Paper Code: 23HUM102

MADANAPALLE INSTITUTE OF TECHNOLOGY & SCIENCE, MADANAPALLE
(UGC-AUTONOMOUS)**B. Tech II Year I Semester (R23) Regular End Semester Examinations, December- 2024**
ECONOMICS AND FINANCIAL ACCOUNTING FOR ENGINEERS

(Common to CST, CSE-AI, CSE-DS, CSE-CS, CSE-AI&ML, CSE-NW)

Time: 3Hrs

Max Marks: 70

Attempt all the questions. All parts of the question must be answered in one place only.
All parts of Q.no 1 are compulsory. In Q.no 2 to 6 answer either A or B only

Q.No	Question	Marks	CO	BL
Q.1	i. Demonstrate law of supply.	1M	1	2
	ii. What do you mean by Economics?	1M	1	1
	iii. Outline production function.	1M	2	1
	iv. Discuss Iso quant.	1M	2	2
	v. Illustrate features of monopolistic.	1M	3	1
	vi. How do you classify the markets?	1M	3	1
	vii. Construct proforma of Balance sheet.	1M	4	2
	viii. Construct proforma of Ledger.	1M	4	2
	ix. Define ratio.	1M	5	2
	x. What is Net present value?	1M	5	1
Q.2(A)	Explain the nature and scope of economics with relevant examples.	12M	1	2
OR				
Q.2(B)	What is elasticity of demand? Illustrative price elasticity of demand.	12M	1	2
Q.3(A)	What is production? Examine production function in the short run.	12M	2	2
OR				
Q.3(B)	List out Breakeven point assumptions and importance.	12M	2	2
Q.4(A)	Elucidate features and price out determination under perfect competition.	12M	3	3
OR				
Q.4(B)	What is pricing? Explain objectives of pricing.	12M	3	2
Q.5(A)	Construct Trading, Profit and Loss a/c and balance sheet as on 31-3-2010 from the following balances of Gopal Krishna.	12M	4	4

Debit balances	Rs.	Credit balances	Rs.
Purchases	25000	Sales	62000
Furniture	3000	Capital	35000
Wages	3500	Creditors	4000
Machinery	20000	Purchase returns	1000
Opening stock	18000		
Sales returns	1000		
Debtors	10000		
Freight	500		
Salaries	10000		
Rent	1000		
Taxes	2000		
Cash at bank	8000		
	102000		102000

Adjustments

1. Closing Stock Rs 16000
2. Outstanding salary Rs.500
3. Prepaid rent Rs. 500
4. Depreciation 10% on Machinery

OR

Q.5(B) Elaborate accounting principles and elucidate accounting concepts and conventions 12M 4 3

Q.6(A) A company is an investment proposal to install new milling controls. The project will cost Rs. 50000. The estimated cash flows before tax are as follows: 12M 5 4

Year	CFAT
1	10000
2	14000
3	16000
4	20000
5	22000

Cost of capital @10%
Years:1-0.909, 2-0.826, 3-0.751, 4-0.683 and 5-0.621
Evaluate: 1. Payback period,2. NPV, and 3. IRR

OR

Q.6(B) What is capital budgeting? Explain capital budgeting techniques with advantages and disadvantages. 12M 5 3

***** END*****

--	--	--	--	--	--	--	--	--	--	--	--	--	--	--	--	--	--	--	--

MADANAPALLE INSTITUTE OF TECHNOLOGY & SCIENCE, MADANAPALLE
(UGC-AUTONOMOUS)

B. Tech II Year I Semester (R23) Regular End Semester Examinations, December- 2024

DISCRETE MATHEMATICAL STRUCTURES

(Common to CST and CSE-CS)

Time: 3Hrs

Max Marks: 70

Attempt all the questions. All parts of the question must be answered in one place only.

All parts of Q.no 1 are compulsory. In Q.no 2 to 6 answer either A or B only

Q.No	Question	Marks	CO	BL
Q.1	i. Draw the truth table for the disjunction $(p \vee q)$.	1M	1	2
	ii. Define predicate logic?	1M	1	1
	iii. Construct the composition table for the set $\{1,3,5,7\}$ under multiplication modulo 8.	1M	2	2
	iv. State the pigeonhole principle.	1M	2	1
	v. Construct the tables of $\{0,1\}$ with the operations $\vee, \wedge, '$ forms a Boolean algebra.	1M	3	2
	vi. State symmetric and asymmetric relation.	1M	3	1
	vii. Write a particular solution for $a_n = 3a_{n-1} + 5^n$.	1M	4	2
	viii. Find the generating function $G(x)$ for the sequence $\{a_n\}$ defined by $a_n = n^n$?	1M	4	2
	ix. Draw a bipartite graph of order 1 and size 11.	1M	5	2
	x. How many edges does a tree with 10 vertices have?	1M	5	2
Q.2(A)	(i) Prove whether the following statement is a tautology, contradiction, or neither: $(p \vee q) \wedge (\neg p \vee \neg q)$ and $(p \wedge \bar{q}) \wedge (\bar{p} \vee q)$. (ii) Use laws of logic to simplify the expressions : $(p \vee (q \wedge \neg p)) \wedge q$ and $(p \vee q) \wedge (\neg p \vee q) \wedge (p \vee \neg q)$	12M	1	3
	OR			
Q.2(B)	(i) show that $S \vee R$ is a tautologically implied by $(P \vee Q) \wedge (P \rightarrow R) \wedge (Q \rightarrow S)$ (ii) show that $R \rightarrow S$ can be derived from the premises $P \rightarrow (Q \rightarrow S)$, $\neg RVP$, and Q .	12M	1	3
Q.3(A)	(i) How many positive integers not exceeding 1000 are divisible by 7 or 11? (ii) How many bit strings of length eight either start with a 1 bit or end with the two bits 00.	12M	2	3
	OR			
Q.3(B)	(i) Show that the set $\{1,2,3,4,5\}$ is not a group under addition and multiplication modulo 6 (ii) Show that $C_5 = \{e, g, g^2, g^3, g^4\}$ is a cyclic group with respect multiplication where $g^5 = e$. Which elements of generate the group C_5 ?	12M	2	3
Q.4(A)	(i) Find the minimal and maximal elements of the poset R on the set $A = \{2,3,4,5,6,7,8\}$, where $x R y$ if and only if x divides y on A . (ii) Draw the Hasse diagram of the set of positive divisors of 30, and determine whether it forms a lattice or not	12M	3	3
	OR			
Q.4(B)	Let $B = \{1,2,3,5,6,10,15,30\}$. Binary operations denoted by \oplus and $*$ and a unary operation denoted by $(-)$ on B are defined as follows: for all $b_1, b_2 \in B$, we have $b_1 \oplus b_2 = lcm(b_1, b_2)$, $b_1 * b_2 = gcd(b_1, b_2)$ and $\bar{b}_1 = 30/b_1$. What are the identity elements with respect to \oplus and $*$? Show that B together with the three operations is a Boolean algebra.	12M	3	3
Q.5(A)	(i) Solve the recurrence relation using generating function $a_n - 9a_{n-1} + 20a_{n-2} = 0$ for $n \geq 2$ and $a_0 = -3, a_1 = -10$ (ii) Solve the following $a_{n+2} - a_{n+1} - 2a_n = n^2$	12M	4	3

OR

Q.5(B) Derive the sequences represented by the following generating functions: 12M 4 3
 (i) $\frac{5+2z}{1-4z^2}$ (ii) $\frac{3-5z}{1-2z-3z^2}$

Q.6(A) Define isomorphism of graphs and mention the sufficient conditions of isomorphism. Determine whether the following graphs are isomorphic 12M 5 3

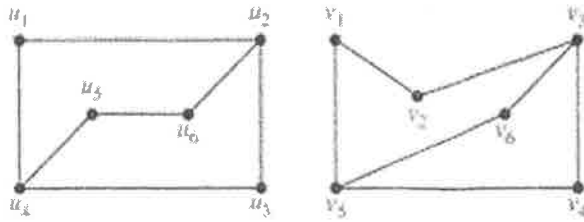

OR

Q.6(B) (i) Construct the **adjacency matrix** and **incidence matrix** for the graph with vertices $V = \{A, B, C, D\}$ and edges $E = \{(A, C), (A, D), (A, E), (B, E), (C, A), (C, B), (C, D), (D, C), (E, D)\}$. 12M 5
 (ii) Show that the following graphs do not have a Hamilton cycles.

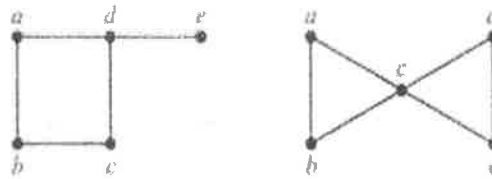

*** END***

--	--	--	--	--	--	--	--	--	--	--	--	--	--	--	--	--	--	--	--

MADANAPALLE INSTITUTE OF TECHNOLOGY & SCIENCE, MADANAPALLE

(UGC-AUTONOMOUS)

B.Tech. II Year I Semester (R23) Regular End Semester Examinations – December 2024**DIGITAL LOGIC AND COMPUTER ORGANIZATION**

(Common to CSE, CST, CSE-AI&ML, CSE-CS, CSE-NW)

Time: 3Hrs**Max Marks: 70**

Attempt all the questions. All parts of the question must be answered in one place only.
All parts of Q.no 1 are compulsory. In Q.no 2 to 6 answer either A or B only

Q.No	Question	Marks	CO	BL
Q.1	i. Express $(-148.75)_{10}$ in Single Precision Floating Point Format.	1M	1	2
	ii. Sketch the logic circuit of a full adder.	1M	1	2
	iii. Classify the types of shift registers.	1M	2	2
	iv. List out various types of computer bus structures.	1M	2	2
	v. Compare CISC and RISC processors.	1M	3	2
	vi. Enumerate the registers of x86 microprocessor.	1M	3	1
	vii. Differentiate between ROM and RAM.	1M	4	1
	viii. Arrange the below given memories in descending order of their speed.	1M	4	1
	ix. Mention the advantages of Clusters	1M	5	1
	x. List out the 6-stages of an Instruction Pipeline.	1M	5	1
Q.2(A)	i) For the given Boolean function $F(w, x, y, z) = \sum m(0, 3, 4, 5, 8, 11, 12, 13, 14, 15)$. Find the minimum SOP Boolean expression using K-map method.	6M	1	3
	ii) Design a 4 X 1 multiplexer using suitable gates.	6M		3
	OR			
Q.2(B)	i) Design 2 line to 4-line Decoder with suitable logic gates.	6M	1	4
	ii) Form the Hamming Code for the data bits 1011. Assume the message is packed in Even Parity Format.	6M		4
Q.3(A)	Explain the working of a JK flip-flop with a neat logic diagram. Tabulate the Characteristic table and Excitation table for JK Flip-flop.	12M	2	2
	OR			
Q.3(B)	Design a 3-bit synchronous Counter using T flip-flops.	12M	2	3
Q.4(A)	Illustrate Restoring Division algorithm with the help of a flow chart. Also divide 12 by 3 using restoring division method.	12M	3	3
	OR			
Q.4(B)	Illustrate the flow chart for floating point addition and subtraction with a suitable example.	12M	3	3
Q.5(A)	i) Explain the various cache mapping techniques.	6M	4	2
	ii) Consider a machine with byte addressable main memory of 64 KB and block size of 8 bytes. Assume a direct mapped cache memory consisting of 32 lines is used with this machine. Determine how this 16-bit memory address is divided into tag, line number and byte number. Into what cache lines would the following addresses "1101 0011 1001 1011" and "1110 1111 1010 1011" get mapped to.	6M		4
	OR			

Q.5(B)	What is RAID? Explain the various Levels of RAID scheme with suitable illustrations.	12M	4	2
Q.6(A)	What are pipeline hazards? Explain in detail about the various types of pipeline hazards.	12M	5	2
OR				
Q.6(B)	Explain the working principle of a DMA with a neat block diagram.	12M	5	2

***** END*****

MADANAPALLE INSTITUTE OF TECHNOLOGY & SCIENCE, MADANAPALLE
(UGC-AUTONOMOUS)

B. Tech II Year I Semester (R23) Regular End Semester Examinations, December- 2024

PROBABILITY AND STATISTICS FOR COMPUTER SCIENCE

(Common to CSE, CSE-DS, CSE-AI, CSE-AIML, CSE-NW)

Time: 3Hrs

Max Marks: 70

Attempt all the questions. All parts of the question must be answered in one place only.
All parts of Q.no 1 are compulsory. In Q.no 2 to 6 answer either A or B only

Q.No	Question	Marks	CO	BL																		
Q.1	i. Let A and B be events such that $p(A) = 0.5$, $p(B) = 0.7$ what must be $p(A \cap B)$ equal for A and B to be independent?	1M	1	1																		
	ii. The function $f(x) = kx^3$ in $0 < x < 1$ is a valid <i>p.d.f.</i> find the value of k ?	1M	1	1																		
	iii. Define binomial distribution.	1M	2	1																		
	iv. State Chebychev's inequality?	1M	2	1																		
	v. Define joint probability density function.	1M	3	1																		
	vi. Find $V(3X + 4Y)$.	1M	3	1																		
	vii. Define coefficient based on quartiles.	1M	4	1																		
	viii. Define Karl Pearson's coefficient of correlation.	1M	4	1																		
	ix. What are two types of errors in statistical hypothesis testing.	1M	5	1																		
	x. Define t-statistic for difference of two sample means.	1M	5	1																		
Q.2(A)	(i) Assume that in a nuclear accident 30% of the workers are exposed to LD_{50} and die; 40% of the workers die; and 68% are exposed to LD_{50} or die. What is the probability that a randomly selected worker is exposed to the LD_{50} ? Find the probability that a randomly selected worker is exposed to LD_{50} but does not die.	6M	1	3																		
	(ii) State and prove Bayes' theorem.	6M	1	3																		
OR																						
Q.2(B)	Let X denote, the number of holes that for can be drilled per bit. The density for X is given the following table:	12M	1	3																		
	<table border="1" style="display: inline-table; border-collapse: collapse; text-align: center;"> <tr> <td>x</td> <td>1</td> <td>2</td> <td>3</td> <td>4</td> <td>5</td> <td>6</td> <td>7</td> <td>8</td> </tr> <tr> <td>$f(x)$</td> <td>0.02</td> <td>0.03</td> <td>0.05</td> <td>0.2</td> <td>0.4</td> <td>0.2</td> <td>0.07</td> <td>$f(8)$</td> </tr> </table>	x	1	2	3	4	5	6	7	8	$f(x)$	0.02	0.03	0.05	0.2	0.4	0.2	0.07	$f(8)$			
x	1	2	3	4	5	6	7	8														
$f(x)$	0.02	0.03	0.05	0.2	0.4	0.2	0.07	$f(8)$														
	(a) Find $f(8)$																					
	(b) Find the table for F																					
	(c) Use F to find the probability that a randomly selected bit can be used to drill between three and five holes inclusive.																					
	(d) Find $p(X \leq 4)$ and $p(X < 4)$. Are these probabilities the same?																					
Q.3(A)	(i) Derive mean and variance of geometric distribution.	6M	2	3																		
	(ii) A computer terminal can pick up an erroneous signal from the keyboard that does not show up on the screen. This creates a silent error that is difficult to detect. Assume that for a particular keyboard the probability that this will occur per entry is $1/1000$. In 5000 entries find the probability that (i) Three silent errors occur (ii) at least 2 silent errors occur (iii) at most 3 silent errors occur	6M	2	3																		

posion

OR

MADANAPALLE INSTITUTE OF TECHNOLOGY & SCIENCE, MADANAPALLE
(UGC-AUTONOMOUS)

B. Tech II Year I Semester (R23) Regular End Semester Examinations, December- 2024
PROBABILITY AND STATISTICS FOR ENGINEERS
(Civil Engineering)

Time: 3Hrs

Max Marks: 70

Attempt all the questions. All parts of the question must be answered in one place only.
All parts of Q.no 1 are compulsory. In Q.no 2 to 6 answer either A or B only

Q.No	Question	Marks	CO	BL
Q.1	i. Let A and B be events such that $p(A) = 0.5$, $p(B) = 0.7$ what must be $p(A \cap B)$ equal for A and B to be independent? ii. Define probability density function. iii. If the mean of a Poisson distribution is 4. Find $P(X=2)$. iv. State Chebyshev's inequality. v. Define joint probability density function. vi. Define Statistical independence of two random variables. vii. Define Standard error of a statistic. viii. Define t-Statistic. ix. What is ANOVA? x. Lay-out of LSD.	1M	1	2
Q.2(A)	A computer center has three printers A, B, and C, which print at different speeds. Programs are routed to the first available printer. The probability that a program is routed to printers A, B and C are 0.6, 0.3 and 0.1 respectively. Occasionally a printer will jam and destroy the printout. The probability that printers A, B and C will jam are 0.01, 0.05 and 0.04 respectively. Your program is destroyed when a printer jams. What is the probability that printer A is involved? Printer B involved? Printer C involved?	12M	1	3
OR				
Q.2(B)	Let X denote the length in minutes of a long-distance telephone conversation and the density for X is given by $f(x) = \frac{1}{10} e^{-\frac{x}{10}}$; $x > 0$. Find (i) $p(X \geq 10)$ (ii) $p(5 \leq X \leq 20)$ (iii) mean (iv) variance	12M	1	3
Q.3(A)	Derive the moment generating function of binomial distribution and then find mean and variance.	12M	2	4
OR				
Q.3(B)	Let X be a Gamma random variable with $\alpha = 3, \beta = 4$ a) What is the expression for the density for X? b) What is the Moment generating function for X? c) Find μ, σ^2, σ	12M	2	2
Q.4(A)	For the following bivariate probability distribution find (i) $E(X)$ and $E(Y)$ (ii) $V(X)$ and $V(Y)$ (iii) Covariance between X and Y (iv) Correlation coefficient between X and Y.	12M	3	4

X\Y	0	1	2	3
0	0.840	0.030	0.020	0.010
1	0.060	0.010	0.008	0.002
2	0.010	0.005	0.004	0.001

OR

- Q.4(B) The joint density for (X, Y) is given by $f(x, y) = \frac{x^3 y^3}{16}$; $0 \leq x \leq 2$ and $0 \leq y \leq 2$. 12M 3 4
- (a) Find the marginal densities for X and Y .
- (b) Are X and Y independent?
- (c) Find $p(X \leq 1)$
- (d) Find $p(X \leq 1, Y \leq 1)$

- Q.5(A) A sample of height of 6400 soldiers have a mean of 67.85 inches and a standard deviation of 2.56 inches while a sample of heights of 1600 sailors has a mean of 68.55 inches and a standard deviation of 2.52 inches. Do the data indicate that the sailors are on the average taller than soldiers? 12M 4 3

OR

- Q.5(B) Two independent sample of sizes 7 and 6 have the values: 12M 4 4
- Sample A: 28 30 32 33 33 29 34
- Sample B: 29 30 30 24 27 29
- Examine whether the samples have been drawn from normal populations having the same variance?

- Q.6(A) The following table shows the lives in hours of three batches of electric lamps: 12M 5 4
- Batch -1: 160, 161, 165, 168, 170, 172, 180
- Batch -2: 158, 164, 164, 170, 175
- Batch -3: 151, 153, 157, 160, 168
- Perform an analysis of variance of these data and state your conclusions.

OR

- Q.6(B) Analyze the variance in the following Latin square of yields (in kgs) of paddy; where A, B, C, D denote the different methods of cultivations: 12M 5 4

		Fertilizers			
Plots	D	A	C	B	
	8	12	19	10	
	B	C	A	D	
	12	18	7	6	
A	B	D	C		
5	22	10	21		
C	D	B	A		
27	12	17	7		

*** END***

MADANAPALLE INSTITUTE OF TECHNOLOGY & SCIENCE, MADANAPALLE
(UGC-AUTONOMOUS)**B. Tech II Year I Semester (R23) Regular End Semester Examinations, December- 2024**
SURVEYING
(Civil Engineering)

Time: 3Hrs

Max Marks: 70

Attempt all the questions. All parts of the question must be answered in one place only.
All parts of Q.no 1 are compulsory. In Q.no 2 to 6 answer either A or B only

Q.No	Question	Marks	CO	BL
Q.1	i. Write down the basic principles of surveying?	1M	1	1
	ii. Difference between plan and map?	1M	1	1
	iii. What are the different types of levelling staff?	1M	2	1
	iv. Write the types of instruments for levelling.	1M	2	1
	v. What is the least count of a theodolite?	1M	3	1
	vi. What is the role of telescope in theodolite?	1M	3	1
	vii. Define compound curve?	1M	4	1
	viii. What are the elements of transition curve?	1M	4	1
	ix. List any two uses of total station?	1M	5	1
	x. Write down the principles of EDM.	1M	5	1

Q.2(A) Explain in detail the various classification schemes of surveying. 12M 1 2

OR

Q.2(B) Following are the bearing taken in a closed compass traverse 12M 1 5

Lines	F.B.	B.B.
AB	S37°30'E	N37°30'W
BC	S43°15'W	N44°15'E
CD	N73°00'W	S72°15'E
DE	N12°45'E	S13°15'W
EA	N60°00'E	S59°00'W

Determine the interior angle and correct them.

Q.3(A) Write in detail about the field procedure and its application of levelling survey. 12M 2 3

OR

Q.3(B) The following readings were taken with a dumpy level and 4m levelling staff. The instrument was shifted after 3rd and 6th readings. The readings are 2.665, 3.225, 2.905, 1.85, 0.98, 2.62, 1.585, 0.96, 0.425m. Enter the above readings in a page of level book and determine R.L. of points, if the first reading was taken with a staff held on B.M. of 100 m. Use rise and fall method. Apply arithmetic checks. 12M 2 5

Q.4(A) Define horizontal and vertical angles? compare about temporary adjustments and permanent adjustments in detail. 12M 3 3

OR

Q.4(B) Determine the gradient from a point P to another point Q from the following observations made with a tachometer fitted with an anallactic lens. The constants of the instrument were 100 and 0 and the staff was held vertical 12M 3 5

Ins. St	Staff Station	Bearing	Vertical Angle	Staff readings (m)
R	P	130°	+10°32'	1.255, 1.810, 2.365
	Q	220°	+ 5°06'	1.300, 2.120, 2.940

Q.5(A)	What are the elements of simple curve? Explain in detail its functions	12M	4	5
OR				
Q.5(B)	How you will classify the curves. Explain with neat sketches	12M	4	3
<hr/>				
Q.6(A)	Briefly explain about the different parts of Total Station with neat sketch?	12M	5	3
OR				
Q.6(B)	How to conduct the survey with EDM and Explain the different types of EDM instruments?	12M	5	3

***** END*****

Hall Ticket No:

--	--	--	--	--	--	--	--	--	--

Question Paper Code: 23CE102

MADANAPALLE INSTITUTE OF TECHNOLOGY & SCIENCE, MADANAPALLE
(UGC-AUTONOMOUS)**B. Tech II Year I Semester (R23) Regular End Semester Examinations, December- 2024**
STRENGTH OF MATERIALS

(Civil Engineering)

Time: 3Hrs

Max Marks: 70

Attempt all the questions. All parts of the question must be answered in one place only.

All parts of Q.no 1 are compulsory. In Q.no 2 to 6 answer either A or B only

Q.No	Question	Marks	CO	BL
Q.1	i. Define Poisson's ratio	1M	1	1
	ii. Differentiate between stress and strain	1M	1	2
	iii. Write the various types of beams	1M	2	1
	iv. Illustrate contra flexure.	1M	2	2
	v. Define the term moment of resistance.	1M	3	1
	vi. Distinguish between bending stress and compound stress	1M	3	2
	vii. Write the torsional formula for a shaft	1M	4	1
	viii. Give an expression for the strain energy stored in a shaft of uniform cross section subjected to torsion.	1M	4	2
	ix. Differentiate between a slope and deflection.	1M	5	2
	x. State the moment area theorem pertaining to the calculation of slope in beams	1M	5	2
Q.2(A)	A compound bar is made with a copper flat of size 50mm x30 mm and a steel plate of 50mm x 40 mm of length 500 mm each placed over the other .. Find the stresses induced in the material, when the composite bar is subjected to an increase temperature of 900C. Take coefficient of thermal expansion of steel as $12 \times 10^{-6} / ^\circ\text{C}$ and that of copper as $18 \times 10^{-6} / ^\circ\text{C}$, modulus of elasticity of copper as 100GPa.	12M	1	3
OR				
Q.2(B)	A load of 100 N falls through a height of 2 cm on to a collar rigidly attached to the lower end of a vertical bar 1.5 m long and of 1.5 cm ² in cross sectional area. The upper end of the vertical bar is fixed. Determine i) Maximum instantaneous stress induced in the bar ii) Maximum instantaneous elongation and iii) Strain energy stored in the vertical rod. Take $E = 2 \times 10^5 \text{ N/mm}^2$.	12M	1	3
Q.3(A)	A cantilever beam of span 5m carries a concentrate load of 1kN, 2kN, 3kN and 2kN At 2m ,3m ,5m form the fixed end resp. Draw the shear force and bending moment diagram.	12M	2	3
OR				
Q.3(B)	Derive an expression for Euler's crippling load, when one end of the column is fixed and other end is hinged.	12M	2	3
Q.4(A)	Find the dimensions of a timber joist b span 5 m to carry a brick wall 200 mm thick and 3.2 m high, if the weight of the brick is 19KN/m ³ and the maximum stress is limited to 8 N/mm ² . The depth is to be twice the width.	12M	3	4
OR				
Q.4(B)	State the assumptions made in the theory of simple bending and derive the bending equation with usual notations.	12M	3	4
Q.5(A)	A shaft transmits is 300KN power at 120 rpm. Determine i) The necessary diameter of solid circular shaft and ii) The necessary diameter of hollow circular section, the inside diameter being 2/3 of the external diameter.	12M	4	4

The allowable shear stress is 70 N/mm^2 . Taking the density of the material is 77 KN/m^3 , calculate the percentage of saving in the material if hollow shaft is used.

OR

Q.5(B) In a material, the principal stresses are 60 MN/m^2 , 48 MN/m^2 and 26 MN/m^2 . Calculate total strain energy, volumetric strain energy, shear strain energy and factor of safety on the total strain energy criterion, if the material yields at 120 MN/m^2 . 12M 4 4

Q.6(A) A cantilever beam of 4 m long carries a load of 50 kN at a distance of 2 m from the free end and a load of W at the free end. If the deflection at the free end is 25mm, calculate the magnitude of the load W, and the slope at the free end. Take $E = 2 \times 10^5 \text{ N/mm}^2$ and $I = 5 \times 10^7 \text{ mm}^4$. 12M 5 3

OR

Q.6(B) A beam AB of span 4 m is simply supported at its ends. The beam carries a concentrate load of 20 kN at 1m from the support A and uniformly distributed load of 10 kN/m in right half span. Assume Flexural rigidity $EI = 4000 \text{ KN/m}^2$. Using Macaulay's method determine the i) Deflection in mid span ii) Maximum deflection and iii) Slope at A 12M 5 3

***** END*****

MADANAPALLE INSTITUTE OF TECHNOLOGY & SCIENCE, MADANAPALLE
(UGC-AUTONOMOUS)**B. Tech II Year I Semester (R23) Regular End Semester Examinations, December- 2024**
23CE104 - FLUID MECHANICS AND HYDRAULICS
(Civil Engineering)

Time: 3Hrs

Max Marks: 70

Attempt all the questions. All parts of the question must be answered in one place only.
All parts of Q.no 1 are compulsory. In Q.no 2 to 6 answer either A or B only

Q.No	Question	Marks	CO	BL
Q.1	i. Differentiate kinematic and dynamic viscosity.	1M	1	2
	ii. State Pascal's law.	1M	1	1
	iii. Write the assumptions made in the derivation of Bernoulli's equation.	1M	2	1
	iv. List out the types of flow.	1M	2	1
	v. Differentiate major and minor head loss.	1M	3	2
	vi. Write the concept of equivalent pipe.	1M	3	1
	vii. Define open-channel flow.	1M	4	1
	viii. What is meant by hydraulically efficient section?	1M	4	1
	ix. Classify GVF profiles	1M	5	2
	x. List out the types of hydraulic jump.	1M	5	1
Q.2(A)	i) Show the rheological classification of fluids and define each type of fluid giving an example.	6M	1	4
	ii) The capillary rise in a glass tube is to be restricted to 3 mm. what should be the diameter of the tube if the surface tension of water in contact with the air is 0.0725N/m.	6M	1	4
OR				
Q.2(B)	Determine the total pressure on a circular plate of diameter 1.5 m which is placed vertically in water in such a way that the centre of the plate is 3 m below the free surface of water. Also find the position of centre of pressure.	12M	1	3
Q.3(A)	If for a two-dimensional potential flow, the velocity potential function is given by $\phi = x(2y-1)$, determine the velocity at the point P (4,5). Determine also the value of stream function (Ψ) at the point P.	12M	2	4
	OR			
Q.3(B)	An orifice meter with orifice diameter 15 cm is inserted in a pipe of 30 cm diameter. The pressure difference measured by a mercury differential manometer on the two sides of the orifice meter gives a reading of 50 cm of mercury. Find the rate of flow of oil of specific gravity 0.9, when the coefficient of discharge of the orifice meter = 0.64.	12M	2	4
Q.4(A)	Two pipes of diameter 400 mm and 200 mm are each 300 m long. When the pipes are connected in series the discharge through the pipeline is 0.10 m ³ /sec, Estimate the loss of head incurred. What would be the loss of head in the system to pass the same total discharge when the pipes are connected in parallel. Take friction factor = 0.0075 for each pipe.	12M	3	4
	OR			
Q.4(B)	A horizontal pipeline 40 m long is connected to a water tank at one end discharges freely into the atmosphere at the other end. For the first 25 m of its length from the tank, the pipe is 150 mm diameter, and its diameter is suddenly enlarged to 300 mm. The height of water level in the tank is 8 m above the centre of the pipe. Considering all losses of	12M	3	4

head which occur. Calculate the rate of flow. Take Darcy's co-efficient of friction as 0.01 for both sections of the pipe.

Q.5(A)	Determine the most economical section of rectangular channel carrying water at the rate of 0.6 cumecs. The bed slope is 1 in 2000. Assume Chezy's constant $C = 50$.	12M	4	3
OR				
Q.5(B)	A Trapezoidal channel with side slope of 2H:3V Has to carry 20 m ³ /s. Find the slope of the channel when the bottom width of the channel is 4 m and the depth of the water is 3 m. Take manning's $n = 0.03$.	12M	4	3
Q.6(A)	The depth of flow of water is 0.3 m at a certain section of rectangular channel of 2 m width. The discharge through the channel is 1.5 m ³ /s. Determine whether a hydraulic jump will occur, if so, determine its height and loss of energy per kilogram of water.	12M	5	4
OR				
Q.6(B)	The efficiency η of geometrically similar fans depends upon the mass density of air ρ , its viscosity μ , speed of the fan N (revolutions per second), diameter of blades D and discharge Q . Perform dimensional analysis using Buckingham's theorem.	12M	5	4

*** END***

MADANAPALLE INSTITUTE OF TECHNOLOGY & SCIENCE, MADANAPALLE
(UGC-AUTONOMOUS)**B. Tech II Year I Semester (R23) Regular End Semester Examinations, December- 2024**
COMPLEX VARIABLES AND TRANSFORMS

(Electrical & Electronics Engineering)

Time: 3Hrs

Max Marks: 70

Attempt all the questions. All parts of the question must be answered in one place only.

All parts of Q.no 1 are compulsory. In Q.no 2 to 6 answer either A or B only

Q.No	Question	Marks	CO	BL
Q.1	i. State Cauchy-Riemann equations in Cartesian form.	1M	1	1
	ii. Define harmonic function.	1M	1	1
	iii. Evaluate the integral $\oint_C \frac{e^z}{z-4} dz$ when $C: z = 2$.	1M	2	1
	iv. Illustrate the Laurent's series expansion of $f(z) = e^z$.	1M	2	2
	v. Find the Laplace transform of e^{5x} .	1M	3	1
	vi. Define unit-step function.	1M	3	1
	vii. Expand the Fourier sine series expansion in $-\pi \leq x \leq \pi$.	1M	4	1
	viii. Write the Fourier cosine transform of $f(t)$.	1M	4	1
	ix. State the linearity property of the Z-transform.	1M	5	1
	x. State the Convolution theorem for Z-transforms.	1M	5	1
Q.2(A)	Prove that the function $f(z)$ defined by $f(z) = \frac{x^3(1+i) - y^3(1-i)}{x^2 + y^2}; (z \neq 0), f(0) = 0$ is continuous and Cauchy-Riemann equations are satisfied at the origin, yet $f'(0) = 0$ does not exist.	12M	1	3
	OR			
Q.2(B)	(i) Show that $u = \frac{1}{2} \log(x^2 + y^2)$ is harmonic and find its harmonic conjugate.	6M	1	3
	(ii) show that $(x^2 - y^2)$ and $\frac{y}{(x^2 + y^2)}$ are harmonic functions but not harmonic conjugate.	6M	1	3
Q.3(A)	(i) Using Cauchy's integral formula, evaluate $\oint_C \frac{\cos \pi z}{z^2 - 1} dz$ around a rectangle with vertices $2 \pm i, -2 \pm i$.	6M	2	3
	(ii) Using Cauchy's integral formula, evaluate $\oint_C \frac{z^2 + 1}{z(2z + 1)} dz$, where C is the circle $ z = 1$.	6M	2	3
	OR			
Q.3(B)	Apply Cauchy Residue theorem to estimate the integral of $f(z) = \frac{\sin z}{z \cos z}$ at its poles inside the circle $ z = 2$.	12M	2	3
Q.4(A)	State and prove Convolution theorem on Laplace transforms.	12M	3	3
	OR			
Q.4(B)	Solve $y'' + 2y' + 5y = 3e^{-x} \sin x$ that satisfies the initial conditions $y(0) = 0$ and $y'(0) = 3$.	12M	3	3
Q.5(A)	(i) If $f(x) = \cos x$, then expand $f(x)$ as a Fourier series in the interval $(-\pi, \pi)$.	6M	4	3
	(ii) Expand $f(x)$ in a Fourier series on the interval $-2 \leq x < 2$ if $f(x) = 0$ for $-2 \leq x < 0$ and $f(x) = 1$ for $0 \leq x < 2$.	6M	4	3
	OR			

- Q.5(B) Find the Fourier transform of $f(x) = \begin{cases} 1 & \text{for } |x| < 1 \\ 0 & \text{for } |x| > 1 \end{cases}$ and hence evaluate $\int_0^\infty \frac{\sin x}{x} dx$. 12M 4 3
-
- Q.6(A) If $U(z) = \frac{2z^2+5z+14}{(z-1)^4}$, find the value of u_2 and u_3 . 12M 5 3
- OR**
- Q.6(B) Using Z-transform, solve $u_{n+2} + 4u_{n+1} + 3u_n = 3^n$ with $u_0 = 0, u_1 = 1$ 12M 5 3

***** END*****

Hall Ticket No:

--	--	--	--	--	--	--	--	--	--

Question Paper Code: 23EEE105

MADANAPALLE INSTITUTE OF TECHNOLOGY & SCIENCE, MADANAPALLE
(UGC-AUTONOMOUS)**B. Tech II Year I Semester (R23) Regular End Semester Examinations, December- 2024****DC MACHINES AND TRANSFORMERS**

(Electrical & Electronics Engineering)

Time: 3Hrs

Max Marks: 70

Attempt all the questions. All parts of the question must be answered in one place only.
All parts of Q.no 1 are compulsory. In Q.no 2 to 6 answer either A or B only

Q.No	Question	Marks	CO	BL
Q.1	i. List the atleast one application of a different D.C. Shunt, Series, differentially compound and cumulative compound Generators.	1M	1	1
	ii. Write about mechanical rectifier	1M	1	1
	iii. Draw the circuit diagram of a short shunt DC compound generator with representing all the circuit parameter.	1M	2	1
	iv. Explain why a DC series motor is preferred for traction applications.	1M	2	1
	v. What advantage has the delta connection?	1M	3	1
	vi. Why the rating of transformer in kVA?	1M	3	1
	vii. how laminating the core of a transformer helps reduce eddy current losses.	1M	4	1
	viii. Differentiate between an autotransformer and a two-winding transformer.	1M	4	1
	ix. Which connection is best suited for a 3-phase, 4-wire system and why?	1M	5	1
	x. What is the main function of an on-load tap changer in a transformer?	1M	5	1
Q.2(A)	(i) Explain the magnetization characteristic of DC Shunt generator	6M	1	2
	(ii) A long shunt compound generator delivers load current of 50A at 500V and has armature, series field and shunt field resistance of 0.05Ω , 0.03Ω and 250Ω respectively. Calculate the generated voltage and armature current. Allow 1V per brush for contact drop.	6M	1	3
OR				
Q.2(B)	(i) Derive the EMF equation of DC generator.	6M	1	3
	(ii) Explain the principle and operation of a DC motor.	6M	1	2
Q.3(A)	250V, D.C.Shunt motor has armature resistance of 0.25Ω , on load it takes an armature current of 50A and runs at 750 r.p.m. if the flux of the motor is reduced by 10% without changing the load torque, find the new speed of the motor.	12M	2	3
OR				
Q.3(B)	(i) Explain how a 3-point starter function. Compare with 4-point starter and justify the scenarios where one might be preferred over the other.	6M	2	2
	(ii) Explain the different speed control techniques of DC shunt motor.	6M	2	2
Q.4(A).	(i) Explain the principle and operation of transformer on no-load and at load condition.	6M	3	3
	(ii) A Single-phase transformer has 400 primary and 1000 secondary turns. The net cross-sectional area of the core is 60cm^2 . if the primary winding be connected to a 50Hz supply at 520V, calculate i) the peak value of flux density in the core ii) the voltage induced in the secondary winding.	6M	3	4

OR

Q.4(B)	Obtain equivalent circuit of a 200/400V, 1-phase 50Hz, transformer gives the following test results: O.C.Test : 200V, 0.7A, 70W - on LV side S.C.Test: 15V, 10A, 85W - on H.V.Side, Calculate the secondary voltage when delivering 5kW at 0.8p.f lagging, the primary voltage being 200V.	12M	3	4
Q.5(A).	(i) Two single phase transformers with equal turns have impedances of $(0.5+j3)\Omega$ and $(0.6+j10)\Omega$ respectively. If they are operated in parallel determine how they will share a total load of 100kW at 0.8 power factor lagging. Also Comment on the result.	6M	4	4
	(ii) List necessary and sufficient conditions for parallel operations of a transformers	6M	4	3
OR				
Q.5(B)	Discuss the advantages and limitations of performing Sumpner's test on transformers. How does this test help in determining the efficiency of transformers under different load conditions?	12M	4	4
Q.6(A).	(i) Explain the Scott connection.	6M	5	2
	(ii) Explain operation of a three winding transformer	6M	5	2
OR				
Q.6(B)	Compare and contrast the operation of three-phase transformers in parallel operation with different voltage ratios. What are the key considerations when connecting transformers of different ratings and voltage ratios in parallel?	12M	5	3

***** END*****

MADANAPALLE INSTITUTE OF TECHNOLOGY & SCIENCE, MADANAPALLE
(UGC-AUTONOMOUS)

B. Tech II Year I Semester (R23) Regular End Semester Examinations, December- 2024

ELECTRICAL CIRCUIT ANALYSIS - II

(Electrical & Electronics Engineering)

Time: 3Hrs

Max Marks: 70

Attempt all the questions. All parts of the question must be answered in one place only.
All parts of Q.no 1 are compulsory. In Q.no 2 to 6 answer either A or B only

Q.No	Question	Marks	CO	BL
Q.1	i. What is the relation between phase & line voltage and phase and line current in a balanced star connected system?	1M	1	1
	ii. If the two-wattmeter method gives readings of 300 W and -100 W, what is the total power?	1M	1	2
	iii. State the shifting theorem of Laplace transform.	1M	2	1
	iv. Define time constant of series RC circuit.	1M	2	1
	v. Write down the condition for symmetry and reciprocity for two port network in terms of hybrid parameters.	1M	3	2
	vi. The impedance matrices of two-port networks are given by $\begin{bmatrix} 12 & 8 \\ 8 & 20 \end{bmatrix}$. Find its admittance matrix.	1M	3	3
	vii. What do you mean by odd symmetry? Give some examples.	1M	4	3
	viii. If the current in a 20 ohm resistor is given by $i=4 + 5\sin\omega t - 3 \cos 3 \omega t$. Determine the power consumed by the resistor.	1M	4	3
	ix. What do you mean by passband and stopband?	1M	5	1
	x. Define propagation constant.	1M	5	1

Q.2(A) For the unbalanced three phase three wire star connected circuit shown in Fig., Using mesh analysis technique, determine the line currents. Let $V_a = 220\angle 0^\circ$, $V_b = 220\angle -120^\circ$, $V_c = 220\angle 120^\circ$ V.

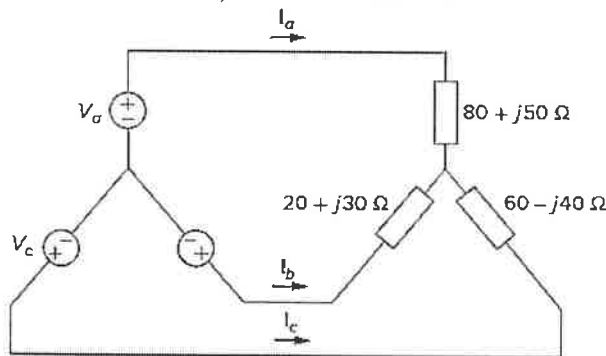

OR

Q.2(B) Prove that two wattmeters are sufficient to measure power in a balanced or unbalanced three phase load connected to a balanced supply. Also obtain the expression for the power factor of the load.

Q.3(A) Apply Laplace Transform, to obtain the step response of a series RLC circuit when switched at $t = 0$.

OR

Q.3(B) A series RL circuit shown in Fig. has a constant voltage $V = 60$ V applied at $t = 0$. Determine the current $i(t)$, time constant, the voltage across resistor and the voltage across the inductor. Sketch $i(t)$.

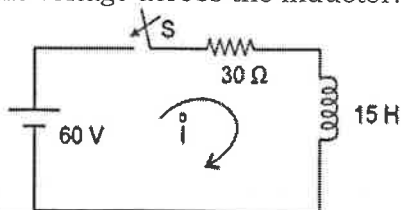

- Q.4(A) Obtain the Z Parameters of the network shown. Determine the ABCD Parameters using the interrelation between them and derive the expressions used. 12M 3 4

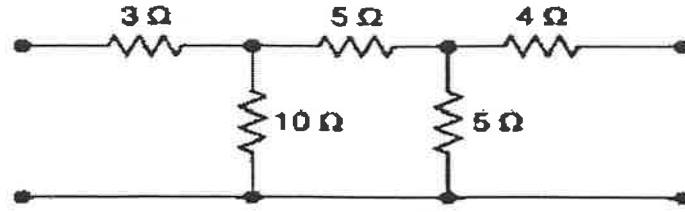

OR

- Q.4(B) Obtain the Y-parameters of the network shown below. Determine the h Parameters using the interrelation between them and derive the expressions used. 12M 3 4

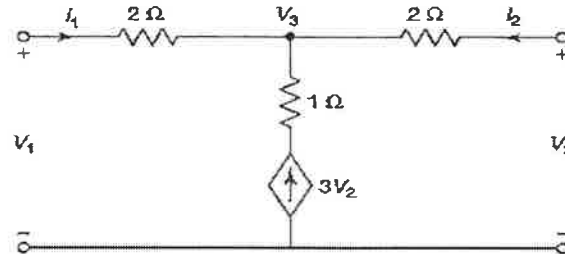

- Q.5(A) Determine the trigonometric fourier series of the waveform shown in Fig. Obtain the amplitude and phase spectra. 12M 4 3

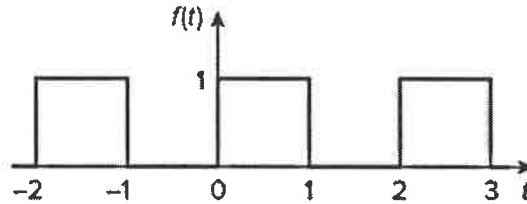

OR

- Q.5(B) Let the function $f(t)$ be the voltage source $v_s(t)$ in the circuit of Fig. Find the response $v_o(t)$ of the circuit. 6M 4 4
- i. $f(t) = 0.5 + \frac{2}{\pi} \sum_{n=1,3,5}^{\infty} \frac{1}{n} \sin n\pi t$

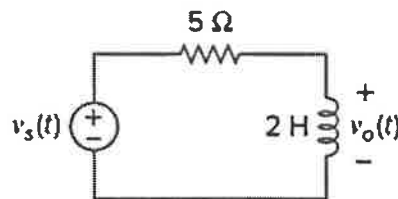

- Q.5(B) ii. Determine the expression for the current in an impedance of $R = 10$ ohm and $L = 0.0318$ H with applied emf $e(t) = 10 + 200\sin 314t + 40 \sin(942t + 30^\circ)$ V. Also calculate the rms value of the voltage and current as well as power factor of the circuit. 6M 4 3

- Q.6(A) In a series LCR type band stop filter, $L=115$ mH, $C=400$ pF and $R=1$ kΩ. Determine the centre frequency, bandwidth, cut-off frequencies, output voltage for an input voltage of 10 V (rms) at f_r , f_1 and f_2 . 12M 5 3

OR

- Q.6(B) Analyse the Constant K low pass filter (both T and π networks) and derive the related design parameters. 12M 5 3

*** END***

MADANAPALLE INSTITUTE OF TECHNOLOGY & SCIENCE, MADANAPALLE
(UGC-AUTONOMOUS)**B. Tech II Year I Semester (R23) Regular End Semester Examinations, December- 2024**
ELECTROMAGNETIC FIELD THEORY

(Electrical & Electronics Engineering)

Time: 3Hrs

Max Marks: 70

Attempt all the questions. All parts of the question must be answered in one place only.

All parts of Q.no 1 are compulsory. In Q.no 2 to 6 answer either A or B only

Q.No	Question	Marks	CO	BL
Q.1	i. Define the electric flux density?	1M	1	1
	ii. State the divergence theorem?	1M	1	1
	iii. Define the relative permittivity?	1M	2	1
	iv. What is dipole moment and its significance?	1M	2	1
	v. Write Maxwell's third & fourth equations in static fields?	1M	3	1
	vi. What is magnetic torque?	1M	3	1
	vii. Write the equation that relates magnetic susceptance and relative permeability.	1M	4	1
	viii. What is the expression of energy stored in inductor?	1M	4	1
	ix. Write Maxwell's first & second equation in time varying fields?	1M	5	1
	x. State the Faraday's law?	1M	5	1
Q.2(A)	Explain about cylindrical coordinate system and derive the transformation matrix expression to convert cylindrical components to cartesian components. (Both component transformation and unit vector transformation).	12M	1	2
OR				
Q.2(B)	i) Derive the electric flux density ((D)) ⁻ and electric field intensity ((E)) ⁻ expression for a point charge distribution using Gauss's law?	6M	1	3
	ii) Two point charges $-4\mu\text{C}$ and $5\mu\text{C}$ are located at (2,-1,3) and (0,4,-2) respectively. Find the potential at (1,0,1)	6M		
Q.3(A)	(i) Derive the necessary expression for integral form of continuity equation of current and the point form of continuity equation of current?	6M	2	3
	(ii) The point charges -1nC , 4nC and 3nC are located at (0,0,0), (0,0,1) and (1,0,0) respectively. Find the energy in the system.	6M		
OR				
Q.3(B)	Determine the capacitance for the following two conductor configured capacitors.	12M	2	3
	i) Parallel plate capacitor ii) Coaxial capacitor iii) Spherical Capacitor			
Q.4(A)	Discuss in detail about the following cases	12M	3	3
	(i) Force acting on a charged particle due to magnetic field. (ii) Force acting on a straight current carrying element due to magnetic field.			
OR				
Q.4(B)	i) Derive magnetic flux density ((B)) ⁻ expression due to magnetic dipole?	6M	3	4
	ii) Derive the magnetic field intensity expression ((H)) ⁻ for a infinite line current distribution and for infinite sheet of current using ampere's law?	6M		
Q.5(A)	i) A coaxial cable consists of an inner conductor of radius 1.2 cm and an outer conductor of radius 1.8 cm. The two conductors are separated by an insulating medium ($\mu=4\mu_0$). If the cable is 3m long and carries 25mA current, calculate the energy stored in the medium?	6M	4	3
	ii) The cross-sectional area of core of a toroid is 12 cm ² and is made of material with $\mu_r = 200$. If the mean radius of the toroid is 50 cm, calculate the number of turns needed to obtain an inductance of 2.5 H.	6M		
OR				

Q.5(B) Discuss in detail about self-inductance and mutual inductance with relevant diagrams? 12M 4 2

Q.6(A) Discuss in detail about maxwell's equations in static fields and time varying fields? 12M 5 4

OR

Q.6(B) A conducting bar can slide freely over two conducting rails as shown in Figure. Calculate the induced voltage in the bar 12M 5 5

(a) If the bar is stationed at $y = 8 \text{ cm}$ and $\vec{B} = 4 \cos 106tz \hat{mWb/m^2}$

(b) If the bar slides at a velocity $(\vec{u}) = 20y \hat{m/s}$ and $\vec{B} = 4z \hat{mWb/m^2}$

(c) If the bar slides at a velocity $\vec{u} = 20y \hat{m/s}$ and

$\vec{B} = 4 \cos (106t-y)z \hat{mWb/m^2}$

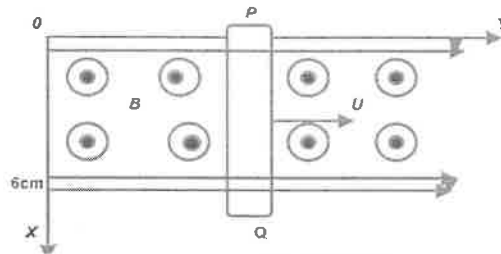

*** END***

Hall Ticket No:

--	--	--	--	--	--	--	--	--	--

Question Paper Code: 23ME105

MADANAPALLE INSTITUTE OF TECHNOLOGY & SCIENCE, MADANAPALLE
(UGC-AUTONOMOUS)

B.Tech II Year I Semester (R23) Regular End Semester Examinations, December- 2024

23ME105 MATERIALS SCIENCE AND ENGINEERING

(Department of Mechanical Engineering)

Time: 3Hrs

Max Marks: 70

Attempt all the questions. All parts of the question must be answered in one place only.
All parts of Q.no 1 are compulsory. In Q.no 2 to 6 answer either A or B only

Q. No	Question	Marks	CO	BL
Q.1	i. Draw the FCC and BCC unit cells.	1M	1	1
	ii. Name the industrially important copper alloy.	1M	1	1
	iii. What is pig iron?	1M	2	1
	iv. What is meant by oil hardening?	1M	2	1
	v. What do you mean by work hardening?	1M	3	1
	vi. What is mean by quenching?	1M	3	2
	vii. Differentiate substitutional and interstitial solid solution with examples?	1M	4	2
	viii. Define Granulation.	1M	4	2
	ix. List out some particle reinforced composites application.	1M	5	2
	x. What is mean by Nanomaterials?	1M	5	2
Q.2(A)	Derive Planar density expression for BCC for the plane (110) and (111) in terms of atomic radius R.	12M	1	2
OR				
Q.2(B)	Enumerate the type of crystal imperfections and explain briefly with a suitable sketch Grain boundary and Twin boundary defects.	12M	1	3
Q.3(A)	Draw the Fe-Fe ₃ C equilibrium diagram to scale on a graph paper and label all points, lines and areas with microstructure.	12M	2	3
OR				
Q.3(B)	What is the purpose of using normalizing, Annealing and Hardening?	12M	2	2
Q.4(A)	Draw an IT diagram or TTT diagram for an eutectoid steel .Indicate the various decomposition products on it and explain?	12M	3	3
OR				
Q.4(B)	Explain the structure and properties of Aluminium and its alloys? Draw the micro structure of pure aluminium.	12M	3	3
Q.5(A)	With a neat flow chart, briefly explain the Powder Metallurgy proce applications.	12M	4	2
OR				
Q.5(B)	How would you apply the Physical Vapor Deposition (PVD) technique to coat a cutting tool for enhanced performance?	12M	4	3
Q.6(A)	Explain the Ceramic matrix composite. Discuss about their properties	12M	5	2
OR				
Q.6(B)	Write brief notes on following traditional ceramics(a) Clay products(b) Glasses(c) Cements(d) Refractory's	12M	5	3

*** END***

MADANAPALLE INSTITUTE OF TECHNOLOGY & SCIENCE, MADANAPALLE
(UGC-AUTONOMOUS)

B. Tech II Year I Semester (R23) Regular End Semester Examinations, December- 2024
MECHANICS OF SOLIDS
(Mechanical Engineering)

Time: 3Hrs

Max Marks: 70

Attempt all the questions. All parts of the question must be answered in one place only.
All parts of Q.no 1 are compulsory. In Q.no 2 to 6 answer either A or B only

Q.No	Question	Marks	CO	BL
Q.1	i. Define Poisson's ratio.	1M	1	1
	ii. Define stress and strain.	1M	1	1
	iii. What are the different types of beams?	1M	2	1
	iv. What is meant by point of contraflexure?	1M	2	1
	v. What is meant by Section Modulus?	1M	3	1
	vi. What are the assumptions in the theory of simple bending?	1M	3	1
	vii. Define torsional rigidity of a shaft.	1M	4	1
	viii. What is the relationship between slope, deflection, and radius of curvature in a beam?	1M	4	1
	ix. Define hoop stress and longitudinal stress.	1M	5	1
	x. Define short and long columns.	1M	5	1

Q.2(A) A circular rod of 25 mm diameter and 500 mm long is subjected to a tensile force of 60 kN. Determine modulus of rigidity, bulk modulus and change in volume. Assume Poisson's ratio = 0.3 and Young's modulus $E = 2 \times 10^5 \text{ N/mm}^2$

OR

Q.2(B) A brass bar, having cross sectional area of 1000 mm^2 , is subjected to axial forces as shown in figure. Find the total elongation of the bar. Take $E = 1.05 \times 10^5 \text{ N/mm}^2$

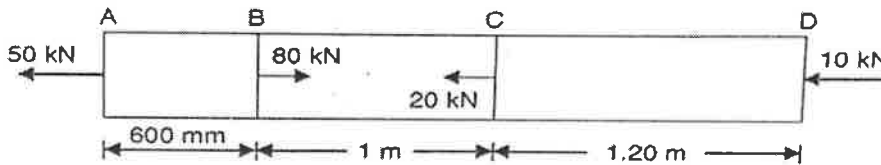

Q.3(A) A cantilever beam of 2m length carries the point loads as shown in Fig. Draw the SFD and BMD for the given beam

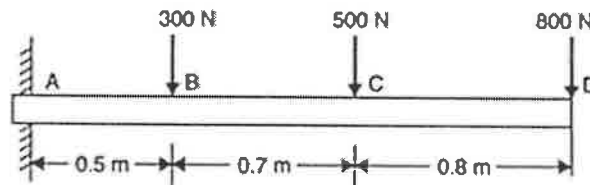

OR

Q.3(B) A simply supported beam carrying number of point loads as shown in figure. Draw the shear force and B.M. diagrams for the cantilever beam.

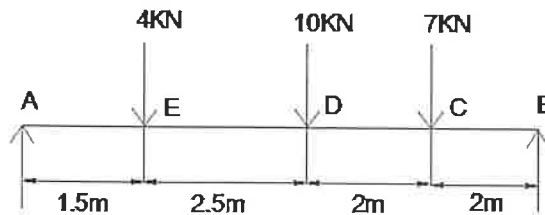

Q.4(A) Derive bending equation $M/I = \sigma/Y = E/R$.

OR

- Q.4(B) The shear force acting on a section of a beam is 50 kN. The section of the beam is of T-shaped of dimensions 100 mm x 100 mm x 20 mm as shown in figure. The moment of inertia about the horizontal neutral axis is $314.221 \times 10^4 \text{ mm}^4$. Calculate the shear stress at the neutral axis and at the junction of the web and the flange.

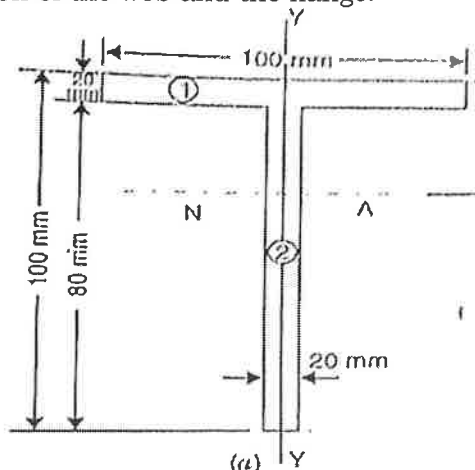

- Q.5(A) Derive pure torsion equation for a circular shaft with assumptions. 12M 4 3
- OR**
- Q.5(B) A beam of length 6m is simply supported at ends and carries two-point loads of 48 kN and 40 kN at distance of 1m and 3m respectively from the left support. Using Macauley's method find
- (i) Deflection under each load
 - (ii) Maximum deflection
 - (iii) Point at which maximum deflection occurs
- Assume, $E = 2 \times 10^5 \text{ N/mm}^2$ & $I = 85 \times 10^6 \text{ mm}^4$ 12M 4 4
-
- Q.6(A) A bar of length 4 m when used as a simply supported beam and subjected to UDL of 30 kN/m over the whole span, deflects 15 mm at the centre. Determine the crippling loads when it is used as a column with following end conditions:
- (i) Both ends pin jointed.
 - (ii) One end fixed, and another end hinged.
 - (iii) Both ends fixed.
- OR**
- Q.6(B) Derive an Expression for Circumference & Longitudinal Stress for thin cylinder. 12M 5 3

*** END***

MADANAPALLE INSTITUTE OF TECHNOLOGY & SCIENCE, MADANAPALLE
(UGC-AUTONOMOUS)**B. Tech II Year I Semester (R23) Regular End Semester Examinations, December- 2024**
NUMERICAL METHODS
(Mechanical Engineering)

Time: 3Hrs

Max Marks: 70

Attempt all the questions. All parts of the question must be answered in one place only.
All parts of Q.no 1 are compulsory. In Q.no 2 to 6 answer either A or B only

Q.No	Question	Marks	CO	BL																
Q.1	i. Illustrate the different kinds of errors in numerical calculation.	1M	1	1																
	ii. If the true value is $7/3$ and approximate value is 2.333, find the absolute error.	1M	1	2																
	iii. State the Gauss backward interpolation formula.	1M	2	1																
	iv. Specify the suitable formula, when the subintervals are unequally spaced?	1M	2	1																
	v. If $h=0.1$, find the number of subintervals.	1M	3	2																
	vi. Illustrate Newton's 2nd derivative interpolation formula.	1M	3	1																
	vii. Define differential equation of first order initial value problem (IVP).	1M	4	1																
	viii. Illustrate the 2nd order Runge-Kutta method formula.	1M	4	1																
	ix. Define curve fitting.	1M	5	1																
	x. Illustrate the normal equations of parabola.	1M	5	1																
Q.2(A)	Determine the real root of the equation, $3x + \sin x - e^x = 0$, by using the bisection method correct up to 4 decimal places.	12M	1	3																
OR																				
Q.2(B)	Find a root of the equation, $x^3 + x^2 - 1 = 0$, by using the fixed point iteration method correct up to 5 decimal places.	12M	1	3																
Q.3(A)	Use Newton's forward & backward formulae to evaluate the value of y when (i) $x=218$ (ii) $x=390$	12M	2	3																
<table border="1" style="margin: auto; border-collapse: collapse;"><tr><td style="padding: 2px 10px;">x</td><td style="padding: 2px 10px;">100</td><td style="padding: 2px 10px;">150</td><td style="padding: 2px 10px;">200</td><td style="padding: 2px 10px;">250</td><td style="padding: 2px 10px;">300</td><td style="padding: 2px 10px;">350</td><td style="padding: 2px 10px;">400</td></tr><tr><td style="padding: 2px 10px;">y</td><td style="padding: 2px 10px;">10.63</td><td style="padding: 2px 10px;">13.03</td><td style="padding: 2px 10px;">15.04</td><td style="padding: 2px 10px;">16.81</td><td style="padding: 2px 10px;">18.42</td><td style="padding: 2px 10px;">19.90</td><td style="padding: 2px 10px;">21.27</td></tr></table>					x	100	150	200	250	300	350	400	y	10.63	13.03	15.04	16.81	18.42	19.90	21.27
x	100	150	200	250	300	350	400													
y	10.63	13.03	15.04	16.81	18.42	19.90	21.27													
OR																				
Q.3(B)	Determine the value of $\tan 14^\circ$ and $\tan 16^\circ$ using Stirling's formula	12M	2	3																
<table border="1" style="margin: auto; border-collapse: collapse;"><tr><td style="padding: 2px 10px;">θ</td><td style="padding: 2px 10px;">0</td><td style="padding: 2px 10px;">5</td><td style="padding: 2px 10px;">10</td><td style="padding: 2px 10px;">15</td><td style="padding: 2px 10px;">20</td><td style="padding: 2px 10px;">25</td></tr><tr><td style="padding: 2px 10px;">$\tan \theta$</td><td style="padding: 2px 10px;">0</td><td style="padding: 2px 10px;">0.0875</td><td style="padding: 2px 10px;">0.1763</td><td style="padding: 2px 10px;">0.2679</td><td style="padding: 2px 10px;">0.3640</td><td style="padding: 2px 10px;">0.4663</td></tr></table>					θ	0	5	10	15	20	25	$\tan \theta$	0	0.0875	0.1763	0.2679	0.3640	0.4663		
θ	0	5	10	15	20	25														
$\tan \theta$	0	0.0875	0.1763	0.2679	0.3640	0.4663														
Q.4(A)	Given data	12M	3	3																
<table border="1" style="margin: auto; border-collapse: collapse;"><tr><td style="padding: 2px 10px;">x</td><td style="padding: 2px 10px;">1.0</td><td style="padding: 2px 10px;">1.1</td><td style="padding: 2px 10px;">1.2</td><td style="padding: 2px 10px;">1.3</td><td style="padding: 2px 10px;">1.4</td><td style="padding: 2px 10px;">1.5</td><td style="padding: 2px 10px;">1.6</td></tr><tr><td style="padding: 2px 10px;">y</td><td style="padding: 2px 10px;">7.989</td><td style="padding: 2px 10px;">8.403</td><td style="padding: 2px 10px;">8.781</td><td style="padding: 2px 10px;">9.129</td><td style="padding: 2px 10px;">9.451</td><td style="padding: 2px 10px;">9.750</td><td style="padding: 2px 10px;">10.031</td></tr></table>					x	1.0	1.1	1.2	1.3	1.4	1.5	1.6	y	7.989	8.403	8.781	9.129	9.451	9.750	10.031
x	1.0	1.1	1.2	1.3	1.4	1.5	1.6													
y	7.989	8.403	8.781	9.129	9.451	9.750	10.031													
Using Newton's forward differentiation formula, evaluate $\frac{dy}{dx}$ and $\frac{d^2y}{dx^2}$ at $x = 1.1$.																				
OR																				
Q.4(B)	Evaluate $\int_0^6 \frac{dx}{1+x^2}$ by taking 6 subintervals (i) Trapezoidal rule (ii) Simpson's $\frac{1}{3}$ rule (iii) Simpson's $\frac{3}{8}$ rule (iv) Actual value.	12M	3	3																
Q.5(A)	Using Picard's method, obtain a solution to the equation $\frac{dy}{dx} = x + y^2$; $y(0) = 0$, find the $y(0.3)$.	12M	4	3																
OR																				
Q.5(B)	Solve the differential equation by 4 th order Runge-Kutta method, given that $\frac{dy}{dx} = xy + y^2$, $y(1) = 1$, find $y(1.1)$ and $y(1.2)$.	12M	4	3																

Q.6(A) (i) Fit a straight line to a given data by the method of least squares 12M 5 3

x	1	2	3	4	5	6	7	8	9
y	9	8	10	12	11	13	14	16	5

(ii) Fit the straight line $y=a+bx$ by using least squares method, find y when $x=2002$.

x	1996	1997	1998	1999	2000
y	40	50	62	58	60

OR

Q.6(B) Fit a curve of the form $y = ab^x$ to the following data: 12M 5 3

x	2	3	4	5	6
y	144	172.8	207.4	248.8	298.5

***** END*****

Hall Ticket No:

--	--	--	--	--	--	--	--	--	--

Question Paper Code: 23ME103

MADANAPALLE INSTITUTE OF TECHNOLOGY & SCIENCE, MADANAPALLE
(UGC-AUTONOMOUS)
B. Tech II Year I Semester (R23) Regular End Semester Examinations, December – 2024
THERMODYNAMICS
(Mechanical Engineering)

Time: 3Hrs

Max Marks: 70

Attempt all the questions. All parts of the question must be answered in one place only.
All parts of Q.no 1 are compulsory. In Q.no 2 to 6 answer either A or B only

Q.No	Question	Marks	CO	BL
Q.1	i. State the difference between path functions and point functions.	1M	1	1
	ii. Define Zeroth law of thermodynamics.	1M	1	1
	iii. Explain the statement of Clausius inequality and its significance in thermodynamics.	1M	2	2
	iv. Define entropy.	1M	2	1
	v. Write about dryness fraction of steam.	1M	3	1
	vi. Write the formula to determine enthalpy of wet steam.	1M	3	1
	vii. State the difference between ideal gas and real gas.	1M	4	1
	viii. Define the Joule-Thomson coefficient.	1M	4	1
	ix. State Dalton's law of partial pressure.	1M	5	1
	x. Define mass fraction.	1M	5	1
Q.2(A)	Explain a quasi-static process with neat sketch and its use in thermodynamics.	12M	1	3
OR				
Q.2(B)	Derive the Steady Flow Energy Equation and explain its significance in thermodynamics.	12M	1	3
Q.3(A)	A heat pump working on the Carnot cycle takes in heat from reservoir at 5°C and delivers heat to a reservoir at 60°C. The heat pump is driven by a reversible heat engine which takes heat in from a reservoir at 840°C and rejects heat to a reservoir at 60°C. The reversible heat engine also drives a device which absorbs 30 kW. If the heat pump extracts 17kJ/s from 5°C reservoir. Determine i) Rate of heat supply from 840°C source. ii) Rate of heat rejection to 60°C sink.	12M	2	4
OR				
Q.3(B)	Water flows through a turbine, and due to friction, its temperature increases from 35°C to 37°C. Assuming no heat transfer, calculate the change in the entropy of water as it passes through the turbine. Consider water to be incompressible and assume the process occurs at constant volume.	12M	2	3
Q.4(A)	Explain P-v, T-s, and h-s diagrams for pure substances and their use in thermodynamic processes and phase changes.	12M	3	4
OR				
Q.4(B)	A Steam power plant operates with the ideal reheat cycle. Steam enters the high pressure turbine at 8MPa and 500°C and leaves at 3MPa. Steam is then reheated at constant pressure to 500°C before it expands to 20kPa in the low pressure turbine. Determine the turbine work output in kJ/kg and thermal efficiency of the cycle. Also show the cycle on a T-s diagram with respect to saturation lines.	12M	3	4

Q.5(A) Explain the compressibility factor and discuss its role in real gas behaviour. 12M 4 3

OR

Q.5(B) Determine the specific volume of water vapour (steam) at a pressure of 20MPa and temperature of 873 K. 12M 4 4

(a) Using the ideal gas equation

(b) Using the vander Waals equation

Assume, $a = 553.8 \text{ kPa (m}^3/\text{kg mole)}^2$ and $b = 0.0305 \text{ m}^3/\text{kg mole}$

Q.6(A) Explain how Dalton's Law and Amagat's Law are used to calculate the total pressure and volume of a non-reactive gas mixture and compare their assumptions and limitations. 12M 5 3

OR

Q.6(B) A mixture of 6 kg of oxygen and 9 kg of nitrogen has a pressure of 3bar and a temperature of 20°C. Determine for the mixture: 12M 5 4

(a) the mole fraction of each component

(b) the molar mass

(c) the specific gas constant, and

(d) the volume

*** END***

--	--	--	--	--	--	--	--	--	--	--	--	--	--	--

ADANAPALLE INSTITUTE OF TECHNOLOGY & SCIENCE, MADANAPALLE
(UGC-AUTONOMOUS)

B. Tech II Year I Semester (R23) Regular End Semester Examinations, December- 2024
COMPLEX VARIABLES AND PROBABILITY THEORY
(Electronics & Communication Engineering)

Time: 3Hrs

Max Marks: 70

Attempt all the questions. All parts of the question must be answered in one place only.
All parts of Q.no 1 are compulsory. In Q.no 2 to 6 answer either A or B only

Q.No	Question	Marks	CO	BL
Q.1	i. Define Complex function.	1M	1	1
	ii. State polar form of Cauchy-Riemann equations	1M	1	1
	iii. Define isolated singularity.	1M	2	1
	iv. Evaluate $\int_C \frac{z}{9-z^2} dz$, where C is the circle $ z = 2$	1M	2	2
	v. Define axiomatic definition of probability.	1M	3	1
	vi. A continuous random variable X having density function $f(x) = k(1-x^2)$; $0 \leq x \leq 1$. Find the value of the constant k ?	1M	3	2
	vii. A random variable has a probability density $f(x) = \frac{1}{10}e^{-\frac{x}{10}}$; $x > 0$. Find $E(X)$	1M	4	2
	viii. Define monotonic transformation of a continuous random variable?	1M	4	1
	ix. If joint p.d.f of X and Y is $f_{X,Y}(x,y) = kxy$; $0 < x < 1$ and $0 < y < 2$ then find the value of k	1M	5	2
	x. Define joint moments of random variable (X,Y) about origin.	1M	5	1
Q.2(A)	Prove that the function $f(z)$ defined by $f(z) = \frac{x^3(1+i) - y^3(1-i)}{x^2 + y^2}$; ($z \neq 0$), $f(0) = 0$ is continuous and Cauchy-Riemann equations are satisfied at the origin, yet $f'(0) = 0$ does not exist.	12M	1	3
	OR			
Q.2(B)	(a) Show that $u = \frac{1}{2} \log(x^2 + y^2)$ is harmonic and find its harmonic conjugate. (b) show that $(x^2 - y^2)$ and $\frac{y}{(x^2 + y^2)}$ are harmonic functions but not harmonic conjugate.	12M	1	2
Q.3(A)	(a) Evaluate $\int_0^{2+i} (z)^2 dz$ along the line $y = x/2$. (b) Evaluate $\oint_C \frac{\sin \pi z^2 + \cos \pi z^2}{(z-1)(z-2)} dz$, where C is the circle $ z = 3$ using Cauchy's integral formula.	12M	2	2
	OR			
Q.3(B)	(a) Expand the function $\sin z$ in a Taylors series about $z = 0$ and determine the region of convergence. (b) Evaluate $\oint_C \frac{\sin \pi z^2 + \cos \pi z^2}{(z-1)^2(z-2)} dz$, where C is the circle $ z = 3$.	12M	2	3
Q.4(A)	In a binary communication system of two transmitted symbols 0, and 1. Define appropriate events A_i and B_j , $i = 1, 2$ to represent symbols after and before channel respectively. Assume channel transition probabilities are all equal at $P(A_i B_j) = 0.1$, $i \neq j$ and are $P(A_i B_i) = 0.9$ for $i = j = 1, 2$, while symbol transmission probabilities are $P(B_1) = 0.6$, and $P(B_2) = 0.4$. Compute the received symbol	12M	3	3

probabilities $P(A_1), P(A_2)$? Compute the posterior probabilities for the system?

OR

- Q.4(B) (i) Assume that the time of arrival of birds at a particular place on a migratory route, as measured in days from the first of the year, is approximated as a Gaussian random variable X with $a_X = 200$ days and $\sigma_X = 20$ days. (a) What is the probability the birds arrive after 160 days but on or before the 210th day? (b) What is the probability the birds will arrive after 231st day?
 (ii) The number of cars arriving at a certain bank drive-in window during any 10-min period is a Poisson random variable X with $\lambda = 2$. Find (i) the probability that more than 3 cars will arrive during any 10-min period. (ii) the probability that no cars will arrive.

12M 3 3

- Q.5(A) (i) For a Gaussian density function, show that $\int_{-\infty}^{\infty} x f_X(x) dx = a_X$.
 (ii) For a Gaussian density function, show that $\int_{-\infty}^{\infty} (x - a_X)^2 f_X(x) dx = \sigma_X^2$.

12M 4 3

OR

- Q.5(B) Given the function $f_{X,Y}(x,y) = \frac{(x^2 + y^2)}{8\pi}; x^2 + y^2 < b$.
 (a) Find the constant b so that this is a valid joint density function.
 (b) Find $P\{0.5b < X^2 + Y^2 \leq 0.8b\}$. (Use polar coordinates in both parts).

12M 4 3

- Q.6(A) Given the function $f_{X,Y}(x,y) = b(x+y)^2; -1 < x < 1$ and $-3 < y < 3$.
 (a) Find the constant b such that this is a valid joint density function.
 (b) Determine the marginal density functions $f_X(x)$ and $f_Y(y)$.
 (c) Find the conditional density functions $f_X(x/Y = y)$ and $f_Y(y/X = x)$
 (d) Are the random variables X and Y statistically independent?

12M 5 4

OR

- Q.6(B) For two random variables X and Y have the joint density $f_{X,Y}(x,y) = \frac{xy}{9}; 0 < x < 2$ and $0 < y < 3$. Find: (a) The first and second order moments, (b) The Covariance and (c) Are X and Y uncorrelated? (d) Show that X and Y are also statistically independent.

12M 5 4

*** END***

Hall Ticket No:

--	--	--	--	--	--	--	--	--	--

Question Paper Code: 23ECE104

MADANAPALLE INSTITUTE OF TECHNOLOGY & SCIENCE, MADANAPALLE
(UGC-AUTONOMOUS)**B.Tech. II Year I Semester (R23) Regular End Semester Examinations – December 2024**
DIGITAL CIRCUITS DESIGN

(ECE)

Time: 3Hrs

Max Marks: 70

Attempt all the questions. All parts of the question must be answered in one place only.
All parts of Q.no 1 are compulsory. In Q.no 2 to 6 answer either A or B only

Q. No	Question	Marks	CO	BL
Q.1	i. Convert decimal $(1023)_{10}$ to equivalent octal number system.	1M	1	1
	ii. Define SOP? Give an example.	1M	1	1
	iii. Write any two advantages of Carry Look-Ahead Adders?	1M	2	1
	iv. Design NAND gate using 2×1 multiplexer.	1M	2	1
	v. How is a reset condition implemented in a Verilog HDL?	1M	3	1
	vi. What is a universal shift register?	1M	3	1
	vii. What is the operation of D flip-flop?	1M	4	1
	viii. Design state diagram of Mod-3 counter.	1M	4	1
	ix. What are the different types of FSM.	1M	5	1
	x. Name the advantages of PLD's.	1M	5	1
Q.2(A)	Why NAND and NOR is called as Universal Gate? Implement all logic gates using NAND & NOR itself.	12M	1	2
OR				
Q.2(B)	(i) Convert the given decimal number $(234)_{10}$ to Binary, Octal, Hexadecimal and BCD Equivalent.	6M	1	2
	(ii) Perform the following using BCD arithmetic operation. a) $(79)_{10} + (177)_{10}$ b) $(481)_{10} + (178)_{10}$	6M		
Q.3(A)	Design and Explain 4-bit binary adder and subtractor using Full adders.	12M	2	2
OR				
Q.3(B)	Examine a 2-bit magnitude comparator using logic gates.	12M	2	2
Q.4(A)	Explain behavioural statement with an example in Verilog HDL.	12M	3	2
OR				
Q.4(B)	With the help of If-else and Case statement design 4:1 Multiplexer in Verilog HDL.	12M	3	2
Q.5(A)	Design a mod-8 synchronous counter with suitable timing diagrams.	12M	4	3
OR				
Q.5(B)	Summarize the 4-bit SISO, PISO shift registers and draw its waveforms.	12M	4	3

Q.6(A)

For the given state diagram, design the circuit using T- Flip Flops.

12M

5 3

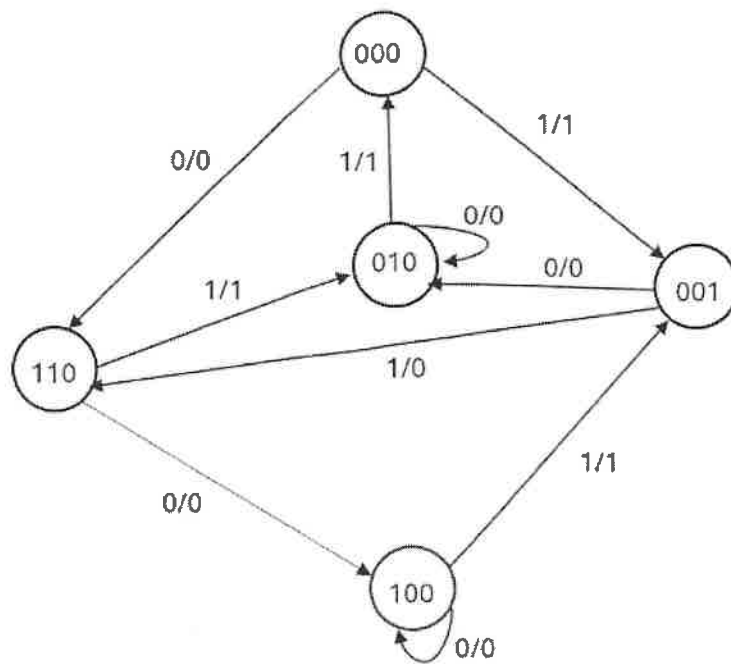

OR

Q.6(B)

- (i) Explain the basic architecture of FPGA?
- (ii) Compare the CPLD and FPGA

6M

5 3

6M

*** END***

--	--	--	--	--	--	--	--	--	--

MADANAPALLE INSTITUTE OF TECHNOLOGY & SCIENCE, MADANAPALLE

(UGC-AUTONOMOUS)

B.Tech. II Year I Semester (R23) Regular End Semester Examinations – December 2024**ELECTRONIC DEVICES AND CIRCUITS**

(ECE)

Time: 3Hrs

Max Marks: 70

Attempt all the questions. All parts of the question must be answered in one place only.

All parts of Q.no 1 are compulsory. In Q.no 2 to 6 answer either A or B only

Q.No	Question	Marks	CO	BL
Q.1	i. Define the terms knee voltage and breakdown voltage.	1M	1	1
	ii. Define Static resistance and Dynamic resistance.	1M	1	1
	iii. Define current amplification factor.	1M	2	1
	iv. Why voltage divider bias is commonly used in amplifier circuit?	1M	2	1
	v. What is the role of the constant current source in MOSFET biasing?	1M	3	1
	vi. Mention the condition under which a MOSFET operates in the saturation region.	1M	3	1
	vii. Write the relationship between the base-emitter resistance and the input resistance of a BJT amplifier.	1M	4	1
	viii. In a BJT common-emitter amplifier, what happens to the voltage gain when an emitter resistor is added?	1M	4	1
	ix. Compare BJT and MOSFET amplifiers.	1M	5	2
	x. Justify why the common-drain amplifier is called a source follower.	1M	5	4
Q.2(A)	Explain the operation of the PN junction diode and VI characteristics under forward and reverse bias.	12M	1	2
OR				
Q.2(B)	i. Describe the construction and working of Varactor diode with the help of V-I characteristics	6M	1	2
	ii. How LED works? Explain in details with neat diagrams.	6M	1	2
Q.3(A)	Draw the circuit diagram of an NPN junction transistor in CE configuration and describe the input and output characteristics.	12M	2	2
OR				
Q.3(B)	i. What is thermal runaway? Derive relevant expressions to obtain thermal stability.	6M	2	3
	ii. In a silicon transistor with a fixed bias, $V_{CC} = 9\text{ V}$, $R_C = 3\text{ k}\Omega$, $R_B = 8\text{ k}\Omega$, $\beta = 50$, $V_{BE} = 0.7\text{ V}$. Find the operating point and stability factor.	6M	2	3
Q.4(A)	Explain the construction and working principle of N-channel E-MOSFET and its characteristics.	12M	3	3
OR				
Q.4(B)	i. Derive the expression for drain current in the saturation region for an n-channel MOSFET.	6M	3	3
	ii. Explain the basic structure of a CMOS logic gate.	6M	3	2
Q.5(A)	Derive the small-signal parameters (r_π , r_o , g_m) of a BJT using the hybrid- π model.	12M	4	4
OR				
Q.5(B)	Derive the input and output resistance expressions for a CC amplifier using the small signal equivalent model.	12M	4	4
Q.6(A)	Derive the input resistance, output resistance, and voltage gain of a CS amplifier with a source resistance using simplified T model.	12M	5	4
OR				
Q.6(B)	Draw the circuit diagram of a Common-Gate (CG) amplifier and explain its operation in detail. Using the simplified T-model, derive the expressions for the voltage gain, input resistance and output resistance	12M	5	4

*** END***

MADANAPALLE INSTITUTE OF TECHNOLOGY & SCIENCE, MADANAPALLE

(UGC-AUTONOMOUS)

B.Tech II Year I Semester (R23) Regular End Semester Examinations – December 2024

SIGNALS AND SYSTEMS

(ECE)

Time: 3Hrs

Max Marks: 70

Attempt all the questions. All parts of the question must be answered in one place only.
All parts of Q.no 1 are compulsory. In Q.no 2 to 6 answer either A or B only

Q.No	Question	Marks	CO	BL
Q.1	i. Sketch the Continuous-time signal given by $u(-0.5t+1)$	1M	1	2
	ii. Find the signal which is energy or power. $f(t) = 4\cos t$	1M	1	2
	iii. Write the scaling property of the unit impulse signal.	1M	2	1
	iv. Find the Nyquist Rate and Nyquist Interval of the following signals. $x(t)=10 \sin 40\pi t * \cos 300\pi t$	1M	2	2
	v. Find the convolution: $u(t + 4) * \delta(t - 8)$.	1M	3	2
	vi. State paly-Wiener criterion and why it is used.	1M	3	2
	vii. Write the model equation for first and second order stationary process.	1M	4	1
	viii. Define stationary random process.	1M	4	1
	ix. What is power spectral density?	1M	5	1
	x. Write the formula to calculate a system's average power spectral density power.	1M	5	1

Q.2(A) A continuous-time signal $x(t)$ is shown below.

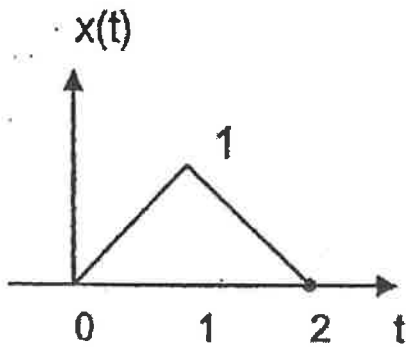

12M 1 3

Sketch

- (i) $y(t)=x(-2t+2)$
- (ii) $y(t)=x(-2t-2)$
- (iii) $y(t)=2x(2t+2)$
- (iv) $y(t)=-2x(2t)$

OR

Q.2(B) Consider the periodic square wave $f(t)$ shown in the following figure. Determine the trigonometric Fourier series of $f(t)$.

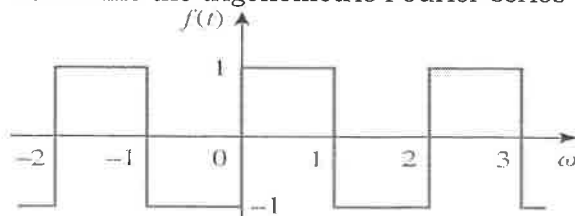

12M 1 3

Q.3(A) Consider the rectangular pulse (gate pulse) and find the Fourier transform of $x(t)$. $x(t) = 2\text{rect}\left(\frac{t}{2T_0}\right)$ 12M 2 3

OR

Q.3(B) Analyse the inverse Laplace transform of reference to the following ROCs. 12M 2 3

$$X(s) = \frac{4}{(s+2)(s+4)}$$

(i) $\text{Re}(s) < -4$

(ii) $\text{Re}(s) > -2$

(iii) $-2 > \text{Re}(s) > -4$.

Q.4(A) Frequency response of the Casual LTI system is given as $H(\omega) = \frac{1}{j\omega+3}$. The system produces the output of $y(t) = e^{-3t}u(t) - e^{-4t}u(t)$, then find the input of the given system. 12M 3 3

OR

Q.4(B) Explain the distortionless Transmission line through an LTI system and how the transfer function defines the ideal low pass filter characteristic. 12M 3 2

Q.5(A) Explain the autocorrelation function for a random process and describe its properties. 12M 4 3

OR

Q.5(B) The Probability density function (PDF) of a uniform random variable is 12M 4 3

$$f(x, y) = \frac{1}{6}; 0 < x \leq 8 \text{ and } 0 < y \leq 3$$

= 0, elsewhere

Find \bar{x} , \bar{y} (Mean) and $E\{XY\}$.

Q.6(A) Derive the expression for Power spectral density and cross-power spectral density of the random process. 12M 5 3

OR

Q.6(B) Given the cross-power spectral density of $X(t)$ and $Y(t)$ is:

$$S_{xy}(f) = \frac{3}{1+f^2}$$

12M 5 3

i. Find the Cross-Correlation Function $R_{xy}(\tau)$

ii. Calculate the Total Power of the Signal assuming $X(t) = Y(t)$

***** END*****

Hall Ticket No:

Question Paper Code: 23CSE105

MADANAPALLE INSTITUTE OF TECHNOLOGY & SCIENCE, MADANAPALLE
(UGC-AUTONOMOUS)

B. Tech II Year I Semester (R23) Regular End Semester Examinations, December- 2024
OBJECT ORIENTED PROGRAMMING THROUGH JAVA
(Computer Science & Engineering)

Time: 3Hrs

Max Marks: 70

Attempt all the questions. All parts of the question must be answered in one place only.
All parts of Q.no 1 are compulsory. In Q.no 2 to 6 answer either A or B only

Q.No	Question	Marks	CO	BL
Q.1	i. What are the escape sequences in Java? Give three examples.	1M	1	1
	ii. Define type casting in Java.	1M	1	1
	iii. Outline the role of this keyword in Java.	1M	2	2
	iv. Extend the purpose of a constructor in a Java class?	1M	2	2
	v. Define inheritance in Java.	1M	3	1
	vi. What is an Array? List the types of arrays.	1M	3	1
	vii. Interpret auto-boxing and auto-unboxing with an example	1M	4	2
	viii. List any three exception classes in Java.	1M	4	1
	ix. Compare String and StringBuffer in Java.	1M	5	2
	x. What is thread priority?	1M	5	1
Q.2(A)	Explain about Object-Oriented Programming (OOP) and its four main principles.	12M	1	2
OR				
Q.2(B)	Illustrate a Java program that calculates the factorial of a number using a for loop and foreach loop.	12M	1	2
Q.3(A)	Build a Java program that illustrates how 'this' keyword can be used to resolve the ambiguity between formal parameters and instance variables.	12M	2	3
OR				
Q.3(B)	Identify the different types of constructors used in Java with examples.	12M	2	3
Q.4(A)	Illustrate declaring an array, initializing it, and accessing its elements. Show how you can modify elements of the array.	12M	3	3
OR				
Q.4(B)	Explain the process of inheritance in Java. How does it promote code reusability and improve software design? Discuss the different types of inheritance (single, multilevel, hierarchical) and provide examples	12M	3	3
Q.5(A)	Explain the hierarchy of exceptions in Java. How are Checked and Unchecked exceptions different? Provide examples of both types of exceptions and explain how they are handled.	12M	4	2
OR				
Q.5(B)	Outline the concept of packages in Java. How are they defined and imported? Illustrate with an example of how to use the java.util package in a program.	12M	4	2
Q.6(A)	Define Thread in Java. Summarize the various methods for creating a thread with examples.	12M	5	2
OR				
Q.6(B)	Illustrate the working of any four methods of String class with example program	12M	5	2

*** END***

MADANAPALLE INSTITUTE OF TECHNOLOGY & SCIENCE, MADANAPALLE
(UGC-AUTONOMOUS)**B. Tech II Year I Semester (R23) Regular End Semester Examinations, December- 2024**
ADVANCED DATA STRUCTURES AND ALGORITHM ANALYSIS
(Computer Science & Engineering)

Time: 3Hrs

Max Marks: 70

Attempt all the questions. All parts of the question must be answered in one place only.

All parts of Q.no 1 are compulsory. In Q.no 2 to 6 answer either A or B only

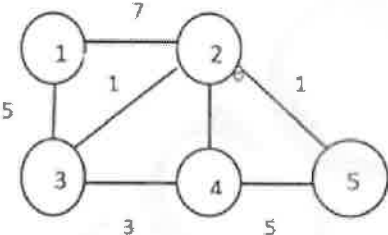
Q.No	Question	Marks	CO	BL
Q.1	i. State the procedures of RL rotation in AVL tree.	1M	1	1
	ii. Define Big O notation and Theta notation.	1M	1	2
	iii. State two applications of graph.	1M	2	1
	iv. List the applications of divide and conquer strategy.	1M	2	2
	v. Define minimum cost spanning tree with an example.	1M	3	2
	vi. State the purpose of Dijkstra's algorithm.	1M	3	1
	vii. Which traversal will be followed by backtracking to identify a solution using SST.	1M	4	2
	viii. Compare branch and bound and back tracking.	1M	4	1
	ix. Define a clique in a graph.	1M	5	2
	x. State the relationship between NP and P problems.	1M	5	1
Q.2(A)	Explain the algorithm for AVL tree insertion and construct an AVL Tree with following data: 10 15 9 12 13 79 45 36 22.	12M	1	3
OR				
Q.2(B)	Define B- Tree. Construct a B-Tree of order 3 for the following key values: 25, 10, 12, 15, 39, 64, 53. Delete key 64 from the above B-Tree and draw resultant B-Tree	12M	1	3
Q.3(A)	Explain the depth first approach of finding articulation points in a connected graph with necessary algorithm.	12M	2	3
OR				
Q.3(B)	Apply Merge sort to the array a= [38, 27, 43, 3, 9, 82, 10, 29] and show the array after each merge step and explain the merging process	12M	2	3
Q.4(A)	Develop Kruskal's algorithm to find minimum spanning tree of a graph. Trace the algorithm for the following graph.	12M	3	3
				
OR				
Q.4(B)	Compare the Bellman-Ford algorithm with Dijkstra's algorithm. Discuss their differences in terms of time complexity, use cases, and handling of graphs with negative weights.	12M	3	4
Q.5(A)	Discuss about back tracking general method. Use back tracking technique, solve the following instance for the sum of subset problem, s=(6,5,3,7) and d=15.	12M	4	2

OR

Q.5(B)	Apply the m-coloring problem for a graph with the following edges using backtracking. Use m=3 colors and provide the coloring sequence: Edges: (1, 2), (1, 3), (2, 3), (2, 4).	12M	4	3
Q.6(A)	Compare non-deterministic and deterministic algorithms. Discuss their significance in computational theory.	12M	5	4
OR				
Q.6(B)	Explain the concept of conjunctive normal form (CNF) and its significance in SAT problems.	12M	5	2

***** END*****

MADANAPALLE INSTITUTE OF TECHNOLOGY & SCIENCE, MADANAPALLE
(UGC-AUTONOMOUS)**B. Tech II Year I Semester (R23) Regular End Semester Examinations, December- 2024**
OBJECT ORIENTED PROGRAMMING THROUGH JAVA

(Computer Science & Technology)

Time: 3Hrs

Max Marks: 70

Attempt all the questions. All parts of the question must be answered in one place only.
All parts of Q.no 1 are compulsory. In Q.no 2 to 6 answer either A or B only

Q.No	Question	Marks	CO	BL
Q.1	i. List the features of Object-Oriented Programming.	1M	1	1
	ii. Write the difference between static variable and instance variable.	1M	1	1
	iii. What is a constructor in Java?	1M	2	1
	iv. How do you create an object in Java?	1M	2	1
	v. Does java support multiple inheritance.?	1M	3	1
	vi. How can you access the super class version of an overridden method?	1M	3	1
	vii. What is a package in Java?	1M	4	1
	viii. What is the difference between exception and error?	1M	4	1
	ix. What is the String class in Java?	1M	5	1
	x. What is synchronization and why is it important?	1M	5	1
Q.2(A)	Elaborate on the various object-oriented concepts, with necessary illustrations.	12M	1	2
OR				
Q.2(B)	Design a program to check whether a given string is a palindrome. Use basic string operations and loops.	12M	1	2
Q.3(A)	Create a class Student with attributes name, Roll Number, and marks for three subjects. Write methods to calculate the total marks and average. Create objects and display details for three students.	12M	2	3
OR				
Q.3(B)	Create a program to demonstrate passing objects as method arguments. Define a class Point with attributes x and y, and a method calculate Distance(Point p) to calculate the distance between two points.	12M	2	3
Q.4(A)	Develop a program to implement multilevel inheritance. Create a class Vehicle, extend it with Car, and further extend Car with Sports Car. Include relevant attributes and methods at each level.	12M	3	3
OR				
Q.4(B)	Design a program to demonstrate method overriding by creating a base class Employee with a method calculate Pay(). Create a subclass Manager that overrides this method to include bonuses.	12M	3	3
Q.5(A)	What is package? State how to create and access user defined package in Java?	12M	4	3
OR				
Q.5(B)	Design a program to demonstrate exception handling. Write a Java program that takes input from the user and handles Arithmetic Exception (e.g., divide by zero) with appropriate messages.	12M	4	3
Q.6(A)	What is a Thread? What are the different states of Thread? Explain the creation of Thread with an example program.	12M	5	2
OR				
Q.6(B)	Design a program to demonstrate the use of String Buffer. Write a program to insert, append, delete, and reverse characters in a string.	12M	5	3

*** END***

Hall Ticket No:

--	--	--	--	--	--	--	--	--	--

Question Paper Code: 23CST102

MADANAPALLE INSTITUTE OF TECHNOLOGY & SCIENCE, MADANAPALLE
(UGC-AUTONOMOUS)**B. Tech II Year I Semester (R23) Regular End Semester Examinations, December- 2024**
DATABASE MANAGEMENT SYSTEMS

(Computer Science & Technology)

Time: 3Hrs

Max Marks: 70

Attempt all the questions. All parts of the question must be answered in one place only.
All parts of Q.no 1 are compulsory. In Q.no 2 to 6 answer either A or B only

Q.No	Question	Marks	CO	BL
Q.1	i. What is a Database? Give an example.	1M	1	1
	ii. What is meant by schema and instance.	1M	1	1
	iii. Define key, give an example?	1M	2	1
	iv. List aggregate functions supported by SQL?	1M	2	1
	v. What is functional dependency?	1M	3	1
	vi. Differentiate lossy and lossless decomposition.	1M	3	2
	vii. Define indexing.	1M	4	1
	viii. What is rollback?	1M	4	1
	ix. Name the three types of data fragmentation.	1M	5	1
	x. Who proposed the CAP theorem?	1M	5	1
Q.2(A)	Explain Database Architecture with neat diagram.	12M	1	2
OR				
Q.2(B)	Compare and contrast File system and DBMS.	12M	1	3
Q.3(A)	Rewrite the following statement into SQL Queries for the following set of tables: EMPLOYEE (EmpNo, Name, DoB, Address, Gender, Salary, DNumber) DEPARTMENT (DNumber, Dname, ManagerEmpNo, MnagerStartDate). i) Display the Age of 'male' employees. ii) Display all employees in Department named 'Marketing'. iii) Display the name of highest salary paid 'female' employee. iv) Which employee is oldest manger in company? v) Display the name of department of the employee 'SMITH'.	12M	2	3
OR				
Q.3(B)	Describe about different type of Join operation with syntax and example.	12M	2	2
Q.4(A)	What is relational algebra? Explain its various operators with examples.	12M	3	3
OR				
Q.4(B)	Illustrate 3NF and BCNF with suitable examples?	12M	3	3
Q.5(A)	Explain 2-phase locking protocol in detail.	12M	4	3
OR				
Q.5(B)	Illustrate about hashing in detail.	12M	4	3
Q.6(A)	Explain Data Fragmentation and Replication.	12M	5	3
OR				
Q.6(B)	Apply CAP theorem on databases?	12M	5	3

*** END***

--	--	--	--	--	--	--	--	--	--

MADANAPALLE INSTITUTE OF TECHNOLOGY & SCIENCE, MADANAPALLE
(UGC-AUTONOMOUS)

B. Tech II Year I Semester (R23) Regular End Semester Examinations, December- 2024
PRINCIPLES OF ARTIFICIAL INTELLIGENCE
(CSE- Artificial Intelligence)

Time: 3Hrs

Max Marks: 70

Attempt all the questions. All parts of the question must be answered in one place only.
All parts of Q.no 1 are compulsory. In Q.no 2 to 6 answer either A or B only

Q.No	Question	Marks	CO	BL
Q.1	i. Briefly explain the following for 8 puzzle problem: a. Initial state b. Actions c. Goal state d. Path cost	1M	1	1
	ii. List any 4 significant AI applications.	1M	1	1
	iii. What are open and closed lists in A* search?	1M	2	1
	iv. What is a heuristic function?	1M	2	1
	v. Demonstrate the Skolemization technique to simplify a logical statement by removing existential quantifiers.	1M	3	2
	vi. Explain the semantic differences between types of quantifiers in First Order Logic.	1M	3	2
	vii. Explain Inductive Reasoning with Deductive Reasoning.	1M	4	2
	viii. Analyze the role of a reward function in Reinforcement Learning.	1M	4	2
	ix. Name a domain where expert systems are commonly applied.	1M	5	1
	x. What was the main application area of the MYCIN expert system?	1M	5	1
Q.2(A)	With a neat diagram, explain the various types of agents.	12M	1	2
OR				
Q.2(B)	Identify and explain the PEAS factors for the following: i. Knitting a sweater ii. Playing Tennis iii. Bidding on an item at an auction iv. Performing high jump v. Medical diagnosis system Satellite image analysis system	12M	1	2
Q.3(A)	Given a heuristic function h_{SLD} (Straight line distance), use A* search algorithm to solve a problem and evaluate the path from Arad to Bucharest. Also state the algorithm, properties and advantages of the A* algorithm.	12M	2	3

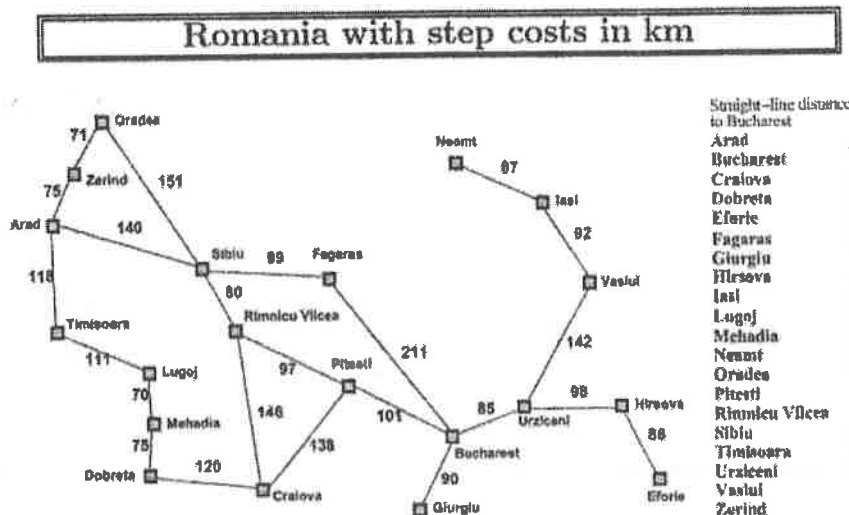

OR

Q.3(B) Apply the Depth First Search Technique for the given graph and state the algorithm. Also discuss the benefits and shortcomings of it. 12M 2 3

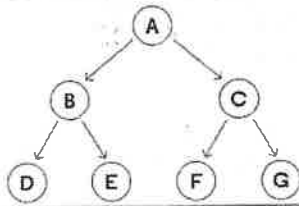

Q.4(A) Provide a comprehensive analysis of constraint propagation for the given problem with the algorithm to solve the following problem. Solve if each letter is a distinct digit, $M \neq 0$ and the solution is unique. 12M 3 3

$$\begin{array}{r} S \ E \ N \ D \\ + \ M \ O \ R \ E \\ \hline M \ O \ N \ E \ Y \end{array}$$

OR

Q.4(B) Produce an in-depth exploration of Bayes' Theorem with an example. 12M 3 3

Q.5(A) Compare Forward Chaining and Backward Chaining in First Order Logic, illustrating their working mechanisms with an example. 12M 4 4

OR

Q.5(B) Analyze the Unification Algorithm and explain how it is applied in inference mechanisms. 12M 4 4

Q.6(A) Illustrate the architecture of an Expert System with the diagram and explain each of its components. 12M 5 2

OR

Q.6(B) Describe the structure of the following systems:
i. MYCIN expert system
ii. DART expert system 12M 5 2

*** END***

MADANAPALLE INSTITUTE OF TECHNOLOGY & SCIENCE, MADANAPALLE
(UGC-AUTONOMOUS)

B. Tech II Year I Semester (R23) Regular End Semester Examinations, December – 2024
ADVANCED DATA STRUCTURES AND ALGORITHM ANALYSIS
(CSE- Artificial Intelligence)

Time: 3Hrs

Max Marks: 70

Attempt all the questions. All parts of the question must be answered in one place only.
All parts of Q.no 1 are compulsory. In Q.no 2 to 6 answer either A or B only

Q.No	Question	Marks	CO	BL
Q.1	i. What is Time Complexity?	1M	1	1
	ii. What is the purpose of asymptotic notation in algorithm analysis?	1M	1	2
	iii. How does Merge Sort works?	1M	2	2
	iv. Write the properties of a minimum spanning tree?	1M	2	1
	v. What is an Optimal Solution?	1M	3	2
	vi. Define Negative-Cycle according to Bellman-Ford algorithm?	1M	3	2
	vii. State the N-Queens problem.	1M	4	1
	viii. Give the idea of Traveling Salesperson problem.	1M	4	2
	ix. Define Chromatic number.	1M	5	1
	x. State the Cook's theorem.	1M	5	1

Q.2(A) Describe Asymptotic Notations and its importance in algorithm analysis. 12M 1 2

OR

Q.2(B) Explain the Depth First Search (DFS) algorithm. How does it work on a given graph? 12M 1 2

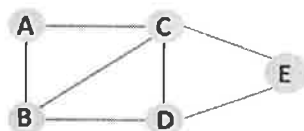

Q.3(A) Describe the Merge Sort algorithm for the list {38,27,43,3,9,82,10}. Analyse its time complexities. 12M 2 3

OR

Q.3(B) Apply Prim's algorithm to find the Minimum Cost Spanning Tree for the given graph. 12M 2 3

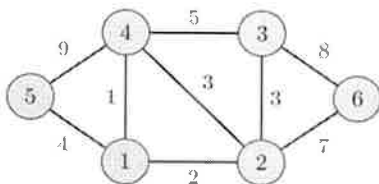

Q.4(A) Use Single-Source Shortest Path (Bellman-Ford) algorithm to find shortest path from source vertex to all other vertices in the given graph. 12M 3 3

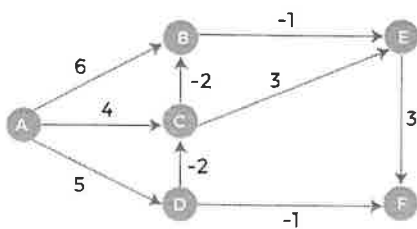

OR

Q.4(B) Explain the Travelling Salesperson Problem (TSP) and how it is solved using Dynamic Programming. 12M 3 3

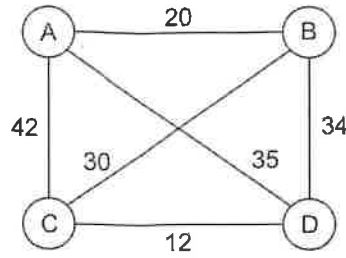

Q.5(A) Demonstrate the Sum of Subsets Problem using Backtracking for the set $S=\{3, 4, 5, 6, 7\}$ and Target sum $T=10$. 12M 4 3

OR

Q.5(B) Describe the Branch and Bound approach for solving the Travelling Salesperson Problem. Provide an example. 12M 4 3

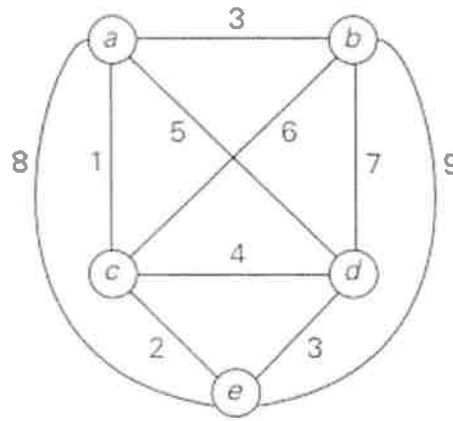

Q.6(A) Explain in detail about the complexity classes P, NP, NP-Hard and NP-Complete. 12M 5 2

OR

Q.6(B) Explain the Clique Decision Problem (CDP) with an example. 12M 5 2

***** END*****

MADANAPALLE INSTITUTE OF TECHNOLOGY & SCIENCE, MADANAPALLE
(UGC-AUTONOMOUS)**B. Tech II Year I Semester (R23) Regular End Semester Examinations, December- 2024**
DATABASE MANAGEMENT SYSTEMS

(CSE- Artificial Intelligence)

Time: 3Hrs

Max Marks: 70

Attempt all the questions. All parts of the question must be answered in one place only.
All parts of Q.no 1 are compulsory. In Q.no 2 to 6 answer either A or B only

Q.No	Question	Marks	CO	BL
Q.1	i. Differentiate between instance and schema.	1M	1	1
	ii. List the limitations of File Processing System.	1M	1	1
	iii. What are aggregate functions? List the aggregate functions supported by SQL.	1M	2	1
	iv. How do you drop triggers?	1M	2	1
	v. Define a super key.	1M	3	1
	vi. State BCNF.	1M	3	1
	vii. Why is the concurrency control needed?	1M	4	1
	viii. What are the properties of transactions?	1M	4	1
	ix. List any two types of NoSQL databases.	1M	5	1
	x. How authorization is differs from authentication model.	1M	5	1
Q.2(A)	Illustrate the basic architecture of a database with the help of the block diagram.	12M	1	2
OR				
Q.2(B)	A car-rental company maintains a database for all vehicles in its current fleet. For all vehicles, it includes the vehicle identification number, license number, manufacturer, model, date of purchase, and color. Special data are included for certain types of vehicles: <ul style="list-style-type: none">• Trucks: cargo capacity.• Sports cars: horsepower, renter age requirement.• Vans: number of passengers.• Off-road vehicles: ground clearance, drive train (four- or two-wheel drive). Construct an E- R model for all operations.	12M	1	3
Q.3(A)	Explain various SQL commands (DDL, DML, DCL, and TCL) with examples of each.	12M	2	2
OR				
Q.3(B)	a) Describe the concept of Referential Integrity.	6M	2	2
	b) Discuss about Stored procedures.	6M	2	2
Q.4(A)	Illustrate operations of relational algebra with examples.	12M	3	2
OR				
Q.4(B)	State 1NF, 2NF & 3NF and explain with examples.	12M	3	2
Q.5(A)	Explain in detail about timestamp-based concurrency control techniques.	12M	4	2
OR				
Q.5(B)	Illustrate the structure and working principles of B+ trees . Construct 20,15,40,65,40,55,80,10,85,70 with order 3.	12M	4	3
Q.6(A)	Explain in detail about Database Authentication, Authorization and access control.	12M	5	2
OR				
Q.6(B)	Discuss the implications of the CAP theorem on distributed database systems. How do NoSQL databases align with the CAP theorem?	12M	5	2

*** END***

Hall Ticket No:

--	--	--	--	--	--	--	--	--	--

Question Paper Code: 23CSD104

MADANAPALLE INSTITUTE OF TECHNOLOGY & SCIENCE, MADANAPALLE
(UGC-AUTONOMOUS)**B. Tech II Year I Semester (R23) Regular End Semester Examinations, December – 2024**
JAVA PROGRAMMING
(CSE-Data Science)

Time: 3Hrs

Max Marks: 70

Attempt all the questions. All parts of the question must be answered in one place only.
All parts of Q.no 1 are compulsory. In Q.no 2 to 6 answer either A or B only

Q.No	Question	Marks	CO	BL
Q.1	i. List the java tokens.	1M	1	1
	ii. Explain command line arguments.	1M	1	2
	iii. How do you create an object of a class in Java?	1M	2	1
	iv. What is the purpose of this keyword?	1M	2	2
	v. Name any three types of inheritance.	1M	3	1
	vi. How to implement an interface in a class?	1M	3	1
	vii. List Java's Built-in Exception.	1M	4	1
	viii. Recall what is package.	1M	4	1
	ix. Define Daemon Threads.	1M	5	1
	x. What is mean by Multithreading.	1M	5	2
Q.2(A)	Define Data Type. Criticize the declaration of variable in Java.	12M	1	4
OR				
Q.2(B)	What is an Array? Explain types of arrays in Java with example.	12M	1	2
Q.3(A)	Define and explain recursive methods, provide an example of recursive method implementation in Object oriented programming.	12M	2	2
OR				
Q.3(B)	What is a Constructor? Explain types of Constructors in Java? Write a java program to find the Area of Circle using Constructor.	12M	2	2
Q.4(A)	Recall Inheritance? Illustrate the types of inheritances with examples.	12M	3	2
OR				
Q.4(B)	Give the differences between Abstract class and Interface.	12M	3	2
Q.5(A)	Contract in detail about throw and throws statements with examples.	12M	4	3
OR				
Q.5(B)	Inspect about multiple clauses with an example of arithmetic Exception.	12M	4	4
Q.6(A)	Define String? Write a java program to check the given string is palindrome or not.	12M	5	2
OR				
Q.6(B)	Explain about Thread Life Cycle with neat sketch.	12M	5	2

***** END*****

MADANAPALLE INSTITUTE OF TECHNOLOGY & SCIENCE, MADANAPALLE
(UGC-AUTONOMOUS)**B. Tech II Year I Semester (R23) Regular End Semester Examinations, December- 2024****DESIGN AND ANALYSIS OF ALGORITHMS**

(CSE-Data Science)

Time: 3Hrs

Max Marks: 70

Attempt all the questions. All parts of the question must be answered in one place only.

All parts of Q.no 1 are compulsory. In Q.no 2 to 6 answer either A or B only

Q.No	Question	Marks	CO	BL																									
Q.1	i. Identify the primary difference between AVL trees and B-trees.	1M	1	2																									
	ii. Represent the data structure used in Breadth First and Depth First graph traversals.	1M	1	1																									
	iii. Distinguish between the Greedy method and Divide and Conquer.	1M	2	2																									
	iv. Write the general method of Greedy technique.	1M	2	1																									
	v. Mention the key differences between fractional and 0/1 Knapsack problem.	1M	3	2																									
	vi. How are negative edge costs handled in finding single source shortest path?	1M	3	2																									
	vii. Give the general method of backtracking.	1M	4	1																									
	viii. List the constraints that must be satisfied in 8-Queens Problem.	1M	4	1																									
	ix. Comprehend the Clique Decision Problem.	1M	5	1																									
	x. What does Cook's Theorem prove in the context of computational complexity?	1M	5	1																									
Q.2(A)	i) Insert the following values into an initially empty AVL Tree. 49, 32, 14, 12, 38, 115, 81, 78, 22, 19, 29, 93, 58, 106, 35 ii) Delete 78, 29 from the constructed AVL tree. iii) Insert 64 into the resulting tree. iv) Show the result of deleting root from the tree.	12M	1	3																									
	OR																												
Q.2(B)	Characterize big-theta, big-omega and big-oh notations with graphical representation. Give suitable example for each.	12M	1	2																									
Q.3(A)	Solve the following Job Sequencing with Deadlines problem: n=5, profits = [20, 15, 10, 5, 1], deadlines = [2, 2, 1, 3, 3]. Show the construction of the schedule and calculate the total profit.	12M	2	3																									
	OR																												
Q.3(B)	You are given the following list of numbers: [38, 27, 43, 3, 9, 82, 10, 58, 97]. Show how the list is recursively divided and how the merge process combines the sublists to produce the sorted result using Merge Sort.	12M	2	3																									
Q.4(A)	Apply Dynamic Programming approach to solve the 0/1 Knapsack Problem. Given the following items with weights and values. <ul style="list-style-type: none">• Item 1: weight = 2, value = 3• Item 2: weight = 3, value = 4• Item 3: weight = 4, value = 5• Knapsack capacity = 5	12M	3	3																									
	OR																												
Q.4(B)	Consider the given adjacency matrix for a weighted directed graph with 4 vertices (A, B, C, D). Apply the Floyd-Warshall algorithm to compute the shortest paths between all pairs of vertices. Show all iterations of the algorithm and the updated distance matrix at each step. Identify the shortest path between the pairs (A, D) and (B, C), and provide the total distance for each.	12M	3	3																									
	<table border="1" style="margin-left: auto; margin-right: auto;"><tr><td></td><td>A</td><td>B</td><td>C</td><td>D</td></tr><tr><td>A</td><td>0</td><td>3</td><td>∞</td><td>7</td></tr><tr><td>B</td><td>∞</td><td>0</td><td>5</td><td>∞</td></tr><tr><td>C</td><td>∞</td><td>∞</td><td>0</td><td>2</td></tr><tr><td>D</td><td>∞</td><td>∞</td><td>∞</td><td>0</td></tr></table>		A	B	C	D	A	0	3	∞	7	B	∞	0	5	∞	C	∞	∞	0	2	D	∞	∞	∞	0			
	A	B	C	D																									
A	0	3	∞	7																									
B	∞	0	5	∞																									
C	∞	∞	0	2																									
D	∞	∞	∞	0																									

Q.5(A)	Solve the 0/1 knapsack maximization problem using the Branch and Bound method for the following data: Number of items (n): 5 Profits (p): 24, 15, 10, 20, 12 Weights (w): 6, 4, 3, 5, 2 Maximum sack capacity (M): 15 Compute the optimal solution, including the total profit earned from the Knapsack.	12M	4	3
OR				
Q.5(B)	Apply the Backtracking approach to solve the 8-Queens problem. Explain the key steps involved and how the algorithm ensures no two queens threaten each other.	12M	4	3
<hr/>				
Q.6(A)	Explain the concept of the Scheduling Identical Processors problem. Discuss the goals and constraints and justify why this is categorized as NP-hard.	12M	5	2
OR				
Q.6(B)	What are NP-Hard and NP-Complete problems? How are these two categories different from one another, and how are they related? Provide examples of each type of problem.	12M	5	2

***** END*****

MADANAPALLE INSTITUTE OF TECHNOLOGY & SCIENCE, MADANAPALLE
(UGC-AUTONOMOUS)**B. Tech II Year I Semester (R23) Regular End Semester Examinations, December- 2024****DATABASE SYSTEMS**

(CSE - Data Science)

Time: 3Hrs

Max Marks: 70

Attempt all the questions. All parts of the question must be answered in one place only.
All parts of Q.no 1 are compulsory. In Q.no 2 to 6 answer either A or B only

Q.No	Question	Marks	CO	BL
Q.1	i. What are the different types of data models in databases? Name any two.	1M	1	1
	ii. Write the difference between an entity and an entity set in the ER model?	1M	1	1
	iii. What is the significance of foreign keys in relational databases?	1M	2	1
	iv. What is the use of cursors in SQL?	1M	2	1
	v. State the conditions for First Normal Form?	1M	3	1
	vi. Differentiate between simple index and complex index?	1M	3	1
	vii. Give the reasons for allowing concurrency?	1M	4	2
	viii. What is the primary purpose of indexing?	1M	4	1
	ix. Describe the need for No SQL databases in modern applications?	1M	5	1
	x. Compare the recent trends in relational and No SQL databases?	1M	5	2
Q.2(A)	A car-rental company maintains a database for all vehicles in its current fleet. For all vehicles, it includes the vehicle identification number, license number, manufacturer, model, date of purchase, and colour. Special data are included for certain types of vehicles: • Trucks: cargo capacity. • Sports cars: horsepower, renter age requirement. • Vans: number of passengers. • Off-road vehicles: ground clearance, drive train (four- or two-wheel drive). Construct an E- R model for all operations.	12M	1	3
	OR			
Q.2(B)	Explain DBMS architecture with examples of centralized and client-server models.	12M	1	2
Q.3(A)	Consider the student table with fields, roll no, name, dept, SUB1, SUB2, SUB3, Total. (i) Apply all aggregate functions to this table. (ii) Display all student names starts with N. (iii) Display all students roll no who's total above 270 and below 290.	12M	2	4
	OR			
Q.3(B)	i) Explain the concept of sub queries in SQL with an example. ii) Describe the different SQL functions for working with date and time data. Provide examples to illustrate their use.	12M	2	2
Q.4(A)	A database table violates 4NF because of a multi-valued dependency. Explain this dependency with an example and demonstrate the decomposition process into 4NF using normalization techniques.	12M	3	3

OR

Q.4(B)	<p>i) Translate the following SQL query into Relational Algebra: SELECT Employee. Name, Department. Name FROM Employee JOIN Department ON Employee. DeptID = Department. DeptID WHERE Employee.Salary>50000;</p> <p>ii) Consider a database with the schema: Student(StudentID, Name, DepartmentID) Department(DepartmentID, DepartmentName) Write Relational Algebra expressions for: a) Listing all student names along with their department names. b) Finding students in the "Computer Science" department.</p>	12M	3	3
Q.5(A)	<p>Explain the structure and properties of a B-Tree in detail. Construct a order 3 by performing the following operations step-by-step:</p> <ul style="list-style-type: none"> • Insert the keys: 10, 20, 5, 6, 12, 30, 7, 17. <p>Illustrate each step with proper diagrams and explain how the B-Tree maintains its properties after each operation.</p>	12M	4	2
OR				
Q.5(B)	<p>Discuss the role of buffer management in recovery techniques and analyze how it interacts with transaction management and concurrency control.</p>	12M	4	4
Q.6(A)	<p>Explain the difference between relational databases and No SQL databases with examples?</p>	12M	5	2
OR				
Q.6(B)	<p>Compare DAC and RBAC by applying their principles to a real-world scenario?</p>	12M	5	3

***** END*****

MADANAPALLE INSTITUTE OF TECHNOLOGY & SCIENCE, MADANAPALLE
(UGC-AUTONOMOUS)**B. Tech II Year I Semester (R23) Regular End Semester Examinations, December- 2024**
DATABASE MANAGEMENT SYSTEMS
(CSE-Cyber Security)

Time: 3Hrs

Max Marks: 70

Attempt all the questions. All parts of the question must be answered in one place only.
All parts of Q.no 1 are compulsory. In Q.no 2 to 6 answer either A or B only

Q.No	Question	Marks	CO	BL
Q.1	i. What is a database?	1M	1	1
	ii. What is the role of ER diagram in database design?	1M	1	2
	iii. Update instructor set salary=salary*1.1. The SQL statement given above is an error. (True/False)	1M	2	2
	iv. Instructor table contains 12 records(rows) and Teaches table contains 21 records. If cartesian product is performed on these tables, how many records will be there in the result table.	1M	2	2
	v. What is functional dependency?	1M	3	1
	vi. What is lossy decomposition?	1M	3	1
	vii. List the operations of transactions.	1M	4	2
	viii. The situation in which a transaction holds a data item and waits for the release of data item held by some other transaction, which in turn waits for another transaction, is called	1M	4	2
	ix. Write syntax of IF statement in PL/SQL with example.	1M	5	2
	x. What is DAC?	1M	5	1
Q.2(A)	(i) What is data abstraction? Explain different levels of data abstraction.	6M	1	3
	(ii) Compare database systems with file systems, highlight the merits of database systems.	6M	1	3
OR				
Q.2(B)	Explain database system architecture with a neat diagram.	12M	1	2
Q.3(A)	Consider the following University database schema and write SQL statements for the given queries.	12M	2	4

classroom(building, room_number, capacity)
department(dept_name, building, budget)
course(course_id, title, dept_name, credits)
instructor(ID, name, dept_name, salary)
section(course_id, sec_id, semester, year, building, room_number, time_slot_id)
teaches(ID, course_id, sec_id, semester, year)
student(ID, name, dept_name, tot_cred)
takes(ID, course_id, sec_id, semester, year, grade)
advisor(s_ID, i_ID)
time_slot(time_slot_id, day, start_time, end_time)
prereq(course_id, prereq_id)

1. Find the department with highest budget
2. Find the total budget of all the departments
3. The exam cell must conduct mid-term examinations, find the number of rooms that can accommodate at least 50 students.
4. Find the number of students who are taking 'CS-101' course.
5. Find the number of courses for which 'CS-101' is acting as prerequisite.
6. Find the 'Computer Science' department courses that give more than 4 credits

OR

Q.3(B) Write in detail about various types of integrity constraints with examples 12M 2 2

Q.4(A) Illustrate redundancy and the problems that redundancy can cause. 12M 3 2

OR

Q.4(B) Describe and illustrate the process of normalizing the table shown below to 3NF. State any assumptions you make about the data shown in this table. 12M 3 4

staffNo	dentistName	patientNo	patientName	appointment		surgeryNo
				date	time	
S1011	Tony Smith	P100	Gillian White	12-Aug-03	10.00	S10
S1011	Tony Smith	P105	Jill Bell	13-Aug-03	12.00	S15
S1024	Helen Pearson	P108	Ian MacKay	12-Sept-03	10.00	S10
S1024	Helen Pearson	P108	Ian MacKay	14-Sept-03	10.00	S10
S1032	Robin Plevin	P105	Jill Bell	14-Oct-03	16.30	S15
S1032	Robin Plevin	P110	John Walker	15-Oct-03	18.00	S13

Q.5(A) Explain ACID properties with suitable examples. 12M 4 2

OR

Q.5(B) What is concurrency control? Explain Time stamp ordering protocol. 12M 4 2

Q.6(A) (i) Write a trigger to not allow any transactions on Employee table on 2nd Saturdays and Sundays 6M 5 3

(ii) Write briefly about DAC, MAC and RBAC 6M 5 2

OR

Q.6(B) Write a PL/SQL program that calculates gross salary and net salary of employees by following the instruction given below. 12M 5 3

a) Create table, employee(id,name,basic_salary,da,hra)

b) Insert 10 records into employee table.

c) Alter table to add the attributes, gross_salary and net_salary

d) Using cursor, calculate gross_salary and net_salary of an employee and update them in employee table.

e) Display the records of employee table.

*** END***

MADANAPALLE INSTITUTE OF TECHNOLOGY & SCIENCE, MADANAPALLE
(UGC-AUTONOMOUS)

B. Tech II Year I Semester (R23) Regular End Semester Examinations, December- 2024
ADVANCED DATA STRUCTURES AND ALGORITHM ANALYSIS
(CSE-Cyber Security)

Time: 3Hrs

Max Marks: 70

Attempt all the questions. All parts of the question must be answered in one place only.
All parts of Q.no 1 are compulsory. In Q.no 2 to 6 answer either A or B only

Q.No	Question	Marks	CO	BL
Q.1	i. Define algorithm.	1M	1	1
	ii. List various rotations in AVL tree	1M	1	1
	iii. Write Pseudocode for Quick Sort and specify its Time complexity.	1M	2	1
	iv. State single source shortest path algorithm	1M	2	1
	v. What is the difference between dynamic programming with divide and conquer method?	1M	3	1
	vi. Define Optimal Binary Search Tree (OBST).	1M	3	1
	vii. How many combinations are possible to place 8 queens in 8x8 chess board?	1M	4	1
	viii. What is Chromatic Number?	1M	4	1
	ix. How NP-hard problems are different from NP-Complete?	1M	5	2
	x. Define Clique decision problem	1M	5	1
Q.2(A)	Construct an AVL tree for a given set of elements {13, 10, 15, 5, 11, 16, 4, and 6}. Insert 14 and analyze the time complexity.	12M	1	3
OR				
Q.2(B)	Explain DFS traversal with example and analyze its time complexity.	12M	1	2
Q.3(A)	Given the jobs, their deadlines and associated profits as shown-	12M	2	4

Jobs	J1	J2	J3	J4	J5	J6
Deadlines	5	3	3	2	4	2
Profits	200	180	190	300	120	100

Answer the following questions-

1. Write the optimal schedule that gives maximum profit.
2. Are all the jobs completed in the optimal schedule?
3. What is the maximum earned profit?

OR

Q.3(B)	Specify Minimum cost spanning trees properties and Explain Prim's algorithm with example.	12M	2	2
Q.4(A)	Apply 0/1 Knapsack problem using Dynamic programming for $n = 4$, $(W1, W2, W3, W4) = (3, 4, 6, 5)$, $(P1, P2, P3, P4) = (2, 3, 1, 4)$, and $M=8$.	12M	3	3
OR				
Q.4(B)	What is single-source shortest path algorithm? Solve the following graph using Bellman Ford Algorithm to calculate shortest path. Analysis its time complexity.	12M	3	4

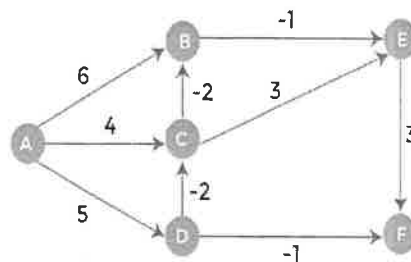

Q.5(A) Color the below given graph with 3 colors using Backtracking algorithm. 12M 4 4

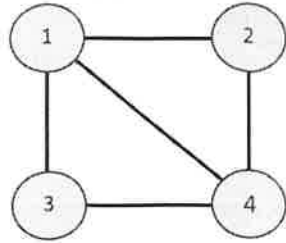

OR

Q.5(B) What do you understand by backtracking? Explain the N-Queens problem with the help of suitable example. 12M 4 4

Q.6(A) Discuss in detail about the class P, NP, NP-hard and NP-complete problems. Give examples for each class. 12M 5 2

OR

Q.6(B) Explain Clique Decision Problem (CDP) with example 12M 5 2

***** END*****

Hall Ticket No:

--	--	--	--	--	--	--	--	--	--

Question Paper Code: 23CSN101

MADANAPALLE INSTITUTE OF TECHNOLOGY & SCIENCE, MADANAPALLE
(UGC-AUTONOMOUS)**B. Tech II Year I Semester (R23) Regular End Semester Examinations, December- 2024**
OBJECT ORIENTED PROGRAMMING THROUGH JAVA
(CSE-Networks)

Time: 3Hrs

Max Marks: 70

Attempt all the questions. All parts of the question must be answered in one place only.
All parts of Q.no 1 are compulsory. In Q.no 2 to 6 answer either A or B only

Q.No	Question	Marks	CO	BL
Q.1	i. What is meant by byte code?	1M	1	1
	ii. Differentiate between class and object.	1M	1	2
	iii. List out the overloaded methods.	1M	2	1
	iv. Write the syntaxes for Passing Arguments by Value and by Reference.	1M	2	2
	v. What is inheritance?	1M	3	1
	vi. Write the Usage of Super.	1M	3	1
	vii. Define a throws clause with an example.	1M	4	1
	viii. What is byte stream?	1M	4	1
	ix. what is thread initial state?	1M	5	1
	x. What is a String in Java?	1M	5	1
Q.2(A)	Illustrate the functioning of various control statements.	12M	1	3
OR				
Q.2(B)	Write a java program for palindrome using command line arguments.	12M	1	3
Q.3(A)	Classify and illustrate the process of various types of Constructors in Java.	12M	2	3
OR				
Q.3(B)	Write a java program to find the factorial value of the given number using recursive methods.	12M	2	3
Q.4(A)	Explain method overriding with example program.	12M	3	2
OR				
Q.4(B)	Write a program to display the name, pages, price and author of a book using interface mechanism.	12M	3	3
Q.5(A)	Explain about Nested try statements with an example.	12M	4	2
OR				
Q.5(B)	Write a program to display the area of circle, triangle and rectangle using user defined package	12M	4	3
Q.6(A)	Write a program for the manipulation of string using different functions of String class.	12M	5	3
OR				
Q.6(B)	Write a program to create multiple threads in JAVA.	12M	5	3

*** END***

Hall Ticket No:

--	--	--	--	--	--	--	--	--	--

Question Paper Code: 23CSN102

MADANAPALLE INSTITUTE OF TECHNOLOGY & SCIENCE, MADANAPALLE
(UGC-AUTONOMOUS)**B. Tech II Year I Semester (R23) Regular End Semester Examinations, December- 2024**
OPERATING SYSTEMS

(CSE – Networks)

Time: 3Hrs

Max Marks: 70

Attempt all the questions. All parts of the question must be answered in one place only.
All parts of Q.no 1 are compulsory. In Q.no 2 to 6 answer either A or B only

Q.No	Question	Marks	CO	BL																		
Q.1	i. What is the purpose of \$# in shell scripting?	1M	1	1																		
	ii. Why is error detection considered a critical OS service?	1M	1	1																		
	iii. Which scheduler is used to move a process from ready state to running state in CPU scheduling?	1M	2	1																		
	iv. What is the key difference between a thread and a process?	1M	2	1																		
	v. Define semaphore.	1M	3	1																		
	vi. What is deadlock ignorance?	1M	3	1																		
	vii. Define page fault.	1M	4	1																		
	viii. What is internal fragmentation?	1M	4	1																		
	ix. Compare contiguous and linked file allocation methods.	1M	5	1																		
	x. What is disk formatting?	1M	5	1																		
Q.2(A)	Design and explain a layered architecture for an operating system.	12M	1	3																		
OR																						
Q.2(B)	Explain the various system calls in operating systems.	12M	1	3																		
Q.3(A)	Explain the various states of a thread. What are the benefits of threads?	12M	2	3																		
OR																						
Q.3(B)	Calculate the average waiting time for the below processes using Round Robin CPU scheduling algorithm. (Time quantum=3 ms). Consider process priority with smallest number has highest priority.	12M	2	3																		
<table border="1" style="margin: auto; border-collapse: collapse;"><thead><tr><th>Process</th><th>CPU Burst Time</th><th>Priority</th></tr></thead><tbody><tr><td>P₁</td><td style="text-align: center;">6</td><td style="text-align: center;">2</td></tr><tr><td>P₂</td><td style="text-align: center;">12</td><td style="text-align: center;">4</td></tr><tr><td>P₃</td><td style="text-align: center;">1</td><td style="text-align: center;">5</td></tr><tr><td>P₄</td><td style="text-align: center;">3</td><td style="text-align: center;">1</td></tr><tr><td>P₅</td><td style="text-align: center;">4</td><td style="text-align: center;">3</td></tr></tbody></table>					Process	CPU Burst Time	Priority	P ₁	6	2	P ₂	12	4	P ₃	1	5	P ₄	3	1	P ₅	4	3
Process	CPU Burst Time	Priority																				
P ₁	6	2																				
P ₂	12	4																				
P ₃	1	5																				
P ₄	3	1																				
P ₅	4	3																				
Q.4(A)	Propose a solution for the Readers-Writers problem using message passing.	12M	3	3																		
OR																						
Q.4(B)	Discuss the Banker's Algorithm and how it ensures deadlock avoidance.	12M	3	2																		
Q.5(A)	Explain a memory allocation strategy for a system using contiguous memory with fixed partitions.	12M	4	3																		
OR																						
Q.5(B)	Consider page reference string 1, 3, 0, 3, 5, 6, 3 with 3-page frames. Find the page fault ratio using FIFO Page Replacement Algorithm.	12M	4	3																		
Q.6(A)	Explain any two free space management techniques for a file system managing disk storage. Discuss the advantages and disadvantages of each technique with an example.	12M	5	3																		
OR																						
Q.6(B)	Given the disk head position at 50, and the disk requests in the following order 98, 183, 37, 122, 14, 124, 65, 67. Compare the total head movements using FCFS (First-Come, First-Served) and SSTF (Shortest Seek Time First) algorithms.	12M	5	3																		

*** END***

MADANAPALLE INSTITUTE OF TECHNOLOGY & SCIENCE, MADANAPALLE
(UGC-AUTONOMOUS)**B. Tech II Year I Semester (R23) Regular End Semester Examinations, December- 2024**
DATABASE MANAGEMENT SYSTEMS
(CSE-AI&ML)

Time: 3Hrs

Max Marks: 70

Attempt all the questions. All parts of the question must be answered in one place only.
All parts of Q.no 1 are compulsory. In Q.no 2 to 6 answer either A or B only

Q.No	Question	Marks	CO	BL																					
Q.1	i. Define a Database.	1M	1	1																					
	ii. Differentiate between schema and instance.	1M	1	2																					
	iii. State NULL values in SQL.	1M	2	1																					
	iv. What is a cursor in SQL?	1M	2	1																					
	v. Define 4NF	1M	3	1																					
	vi. What is relational calculus?	1M	3	1																					
	vii. Mention the purpose of recovery techniques in a database?	1M	4	1																					
	viii. Define ACID properties.	1M	4	1																					
	ix. Explain discretionary access control (DAC)	1M	5	1																					
	x. What is NoSQL?	1M	5	1																					
Q.2(A)	Compare and contrast the differences between File systems Vs Database systems.	12M	1	2																					
OR																									
Q.2(B)	Illustrate the importance of structural constraints in ER modeling.	12M	1	2																					
Q.3(A)	Write SQL queries to demonstrate the use of GROUP BY and HAVING clauses. (Four Queries)	12M	2	3																					
OR																									
Q.3(B)	Explain the concept of dynamic SQL with an example.	12M	2	2																					
Q.4(A)	Discuss the steps for normalizing a database to 4NF. Consider the following table capturing information about students' skills and hobbies:	12M	3	3																					
<table border="1" style="margin: auto;"><thead><tr><th>StudentID</th><th>Skill</th><th>Hobby</th></tr></thead><tbody><tr><td>101</td><td>Programming</td><td>Chess</td></tr><tr><td>101</td><td>Programming</td><td>Music</td></tr><tr><td>101</td><td>Writing</td><td>Chess</td></tr><tr><td>101</td><td>Writing</td><td>Music</td></tr><tr><td>102</td><td>Painting</td><td>Reading</td></tr><tr><td>102</td><td>Painting</td><td>Traveling</td></tr></tbody></table>					StudentID	Skill	Hobby	101	Programming	Chess	101	Programming	Music	101	Writing	Chess	101	Writing	Music	102	Painting	Reading	102	Painting	Traveling
StudentID	Skill	Hobby																							
101	Programming	Chess																							
101	Programming	Music																							
101	Writing	Chess																							
101	Writing	Music																							
102	Painting	Reading																							
102	Painting	Traveling																							
OR																									
Q.4(B)	Explain relational algebra operations with examples.	12M	3	2																					
Q.5(A)	Discuss the ACID properties of a database transaction with examples.	12M	4	3																					
OR																									
Q.5(B)	Compare B-tree and B+-tree indexing with examples.	12M	4	3																					
Q.6(A)	What is SQL injection? Explain its effects and preventive measures.	12M	5	2																					
OR																									
Q.6(B)	Discuss the CAP theorem in detail and its implications on NoSQL databases.	12M	5	3																					

*** END***

Hall Ticket No:

--	--	--	--	--	--	--	--	--	--

Question Paper Code: 23CSM101

MADANAPALLE INSTITUTE OF TECHNOLOGY & SCIENCE, MADANAPALLE
(UGC-AUTONOMOUS)**B. Tech II Year I Semester (R23) Regular End Semester Examinations, December- 2024**
PYTHON PROGRAMMING

(CSE- AI&ML)

Time: 3Hrs

Max Marks: 70

Attempt all the questions. All parts of the question must be answered in one place only.
All parts of Q.no 1 are compulsory. In Q.no 2 to 6 answer either A or B only

Q.No	Question	Marks	CO	BL
Q.1	i. Write a python program to print all the keywords.	1M	1	1
	ii. Define input and output functions in python with syntax.	1M	1	2
	iii. Define comparison operators in python.	1M	2	2
	iv. What is expression? Give an example.	1M	2	1
	v. Define List with syntax.	1M	3	1
	vi. Define Dictionary with syntax.	1M	3	1
	vii. What are python string operations?	1M	4	1
	viii. Define Namespace.	1M	4	1
	ix. Write the syntax of open().	1M	5	1
	x. List out the modes of a file.	1M	5	1
Q.2(A)	Discuss about the different data types present in python with example programs.	12M	1	3
OR				
Q.2(B)	Write python program to perform different Mathematical Computations. perform all the operations present in a Scientific Calculator.	12M	1	3
Q.3(A)	If the age of Ram, Sam and Khan are input through the keyboard, write a python program and algorithm using nested if-else to determine the eldest and youngest of the three.	12M	2	3
OR				
Q.3(B)	Briefly Explain about Control Statements in Python with example programs.	12M	2	2
Q.4(A)	Explain the built-in functions of Dictionary with an example script for each function.	12M	3	2
OR				
Q.4(B)	i) Implement Python script to display power of given numbers using function with algorithm.	6M	3	3
	ii) Implement a Python program and algorithm that takes a list of words and returns the length of the longest one using function	6M	3	3
Q.5(A)	Discuss about the following directory methods with syntax and examples. a) mkdir() b) chdir() c) getcwd() d) rmdir() e) listdir()	12M	4	3
OR				
Q.5(B)	Briefly discuss about range function related to string in python with examples.	12M	4	3
Q.6(A)	Explain in detail about Python Files, its types and operations that can be performed on files with examples.	12M	5	2
OR				
Q.6(B)	What is an Exception? Explain about exception handling with an example program.	12M	5	2

*** END***